

Haeger®

Creating Hardware Insertion Profit Centers



*A comprehensive guide
to ordering Haeger tooling
for the manual installation
of self-clinching fasteners.*

Manual Tooling Catalog

SECTION 1 INTRODUCTION

Preface 1.1
Using the Tooling Catalog 1.2

SECTION 2 BASIC TOOLING

Standoff Tooling 2.1
Nut Tooling, Pin Style 2.2
Stud Tooling, Inch 2.3
Stud Tooling, Metric 2.4
Nut Tooling, Pocket Style, Inch 2.5
Nut Tooling, Pocket Style, Metric 2.6
Anvils 2.7
Soft Face Tooling 2.7
Adapters & Extenders 2.8
Stud Depressor Tooling, Inch 2.9
Stud Depressor Tooling, Metric 2.10

SECTION 3 ROTARY TOOLING

Rotary Nut Tooling 3.1
Rotary Stud Tooling 3.2

SECTION 4 J-FRAME NUT TOOLING

J-Frame Tool Holder 4.1
J-Frame Nut Tooling, Pocket Style 4.2
J-Frame Nut Tooling, Pin Style 4.2
J-Frame Tool Holder 4.3
J-Frame Stud Tooling 4.4

SECTION 5 MISCELLANEOUS

SP Nut Lower Tool 5.1
TD Lower Tool 5.2
Right Angle Fastener Tool 5.3
FH4 Stud Coining Ring Tool 5.4
Panel Fastener Tooling, Anvil, Inch 5.5
Panel Fastener Tooling, Anvil, Metric 5.6

SECTION 5 MISCELLANEOUS CONT

Panel Fastener Tooling, Punch, Inch 5.7
Panel Fastener Tooling, Punch, Metric 5.8
Miniature Nut Tooling, Inch 5.9
Miniature Nut Tooling, Metric 5.10
Floating Nut Tooling, Inch 5.11
Floating Nut Tooling, Metric 5.12
Self Locking Nut Tooling 5.13
Hex Self Locking Nut Tooling 5.14

SECTION 6 SOUTHCO

Retractable Screw Assembly No. 47, Press In Type 6.1
Retractable Screw Assembly No. 47, Flare Type 6.1
Retractable Screw Assembly No. 47, Back-Up Tooling 6.2

SECTION 7 RIVETS

Universal Head Solid Rivet Tooling 7.1
Round Head Solid Rivet Tooling 7.2
Tubular Roll Rivet Tooling 7.3
Tubular Flare Rivet Tooling 7.4
Tubular Rivet Dolly Tooling 7.5
Buck Tooling 7.6

SECTION 8 HANK RIVET BUSH

Hexagonal Hank Bush Tooling 8.1
Round & Tank Hank Bush Tooling 8.1
Hank Mini-Sert Tooling 8.2

SECTION 9 KERB KONUS

Punch, MINI ANCHOR Tooling 9.1
Punch ANCHOR Tooling 9.2

SECTION 10 STANDARD MANUAL TOOLING PACKAGES

Standard Tooling Package 10.1
Metric Tooling Package 10.2
412 & J Frame Standard Tooling Package 10.3
412 & J Frame Metric Tooling Package 10.4

SECTION 11 BTM JOINING TOOLING

General Description 11.1
Set Up 11.2
Process 11.3
Technical Description 11.4
Joint Sizes 11.5
Punch & Die Assemblies 11.6
Joint Data Table .12 Punch 11.7
Joint Data Table 3mm Punch 11.8
Joint Data Table .18 Punch 11.9
Joint Data Table 4.6mm Punch 11.10
.12 Joint BTM Drawing 11.11
.12 Joint BTM Tooling 11.12
.18 Joint BTM Drawing 11.13
.18 Joint BTM Tooling 11.14

SECTION 12 TOOL HOLDERS

BTM Upper Tool Holder 12.1
Quick Change Lower Tool Holder 12.2
BTM Lower Tool Holder 12.3
Square Tip Lower Tool Holder 12.4

Haeger, Inc. is widely recognized as the industry leader in the development and implementation of innovative self-clinching fastener installation technologies. For over twenty years, Haeger engineers have been designing and building flexible systems for installing practically every kind of self-clinching fastener into practically every kind of work piece - creating new technologies to help Haeger owners get just about any job done productively and profitably.

Over the years, Haeger's innovative tooling and patented quick-change automatic fastener feeding systems have revolutionized the way the world's fabricators and manufacturers install hardware.

So whenever your operation faces an insertion challenge, turn to the manufacturer with the most experience in developing self-clinching fastener insertion solutions. Turn to Haeger.



811 Wakefield Drive
Oakdale, California 95361
(209) 848-4000
FAX (209) 847-6553

Fasteners

The Standoff, Stud and Nut Tools listed in this catalog are designed to be used with standard fasteners, such as those manufactured by Captive Fastener Corporation and PEM (Penn Engineering & Manufacturing Corporation).

Fasteners, such as Camcar's Strux line are slightly larger and require different tooling which can be supplied by Haeger's Specials Group. Please consult your local Haeger Distributor for further information.

Unless otherwise noted, the maximum length stud these tools will accommodate is 1.25 in./31.7 mm.

Delivery

The tools and tool holders in Sections 2, 3, 4, 9, 10, 11 and 12 are stocked and are available for immediate shipment. The tools in Sections 5, 6, 7 and 8 may be subject to a two week lead time.

Drawing Dimensions

In all drawings found in this catalog, the dimensions A, B and C are defined as follows:

- A. Overall length of the tool
- B. Height the tool extends above the Lower Tool Holder
- C. Largest diameter of the tool

Other tool dimensions found in the catalog will always be labeled D or higher in the alphabet.

Inch/Metric Dimensions

Some of the tools in this catalog may be used for both inch and metric fasteners. In these cases, the inch and metric part numbers are identical. They are listed separately for the convenience of the user.

If only inch or only metric tools are available, the tools are dual dimensioned.

Flush Nut Installation

Flush nuts can be installed using two flat anvils with diameters larger than the nut.

J-Frame Tooling

In addition to being used in the J-Frame, this tooling may also be used in the Square Tip Lower Tool Holder.

Standoff Tooling

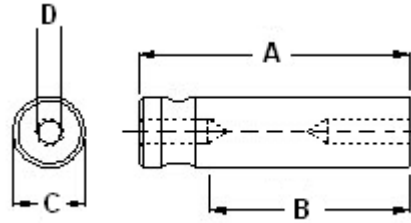

INCH

Part #	Fastener Size	Dim. A in	Dim. B in	Dia. C in	Dia. D in
H-109-4/M3S	4-40	1.5	1.0	.50	.168
H-109-6/M3.5S	64-40 & 6-32	1.5	1.0	.50	.215
H-109-8-10/M5S	86-32, 8-32 & 10-32	1.5	1.0	.50	.283
H-109-4/M3L	4-40	3.0	2.5	.50	.168
H-109-6/M3.5L	64-40 & 6-32	3.0	2.5	.50	.215
H-109-8-10/M5L	86-32, 8-32 & 10-32	3.0	2.5	.50	.283

Note: Maximum length inch standoff is 1.062 in.

METRIC

Part #	Fastener Size	Dim. A mm	Dim. B mm	Dia. C mm	Dia. D mm
H-109-4/M3S	M3	38.1	25.4	12.7	4.26
H-109-6/M3.5S	3.5M3	38.1	25.4	12.7	5.46
H-109-8-10/M5S	M4 & M5	38.1	25.4	12.7	7.18
H-109-4/M3L	M3	76.2	63.5	12.7	4.26
H-109-6/M3.5L	3.5M3	76.2	63.5	12.7	5.46
H-109-8-10/M5L	M4 & M5	76.2	63.5	12.7	7.18

Note: Maximum length metric standoff is 27 mm.

Caution: When using short tooling (1.5 in./38.1 mm long) and the threaded hole in the bottom of the tool to secure it in the lower tool holder, make sure the cap screw used to secure the tool provides adequate clearance for the standoff.

S, SS, CLS, CLSS, C, CS

Nut Tooling
Pin Style

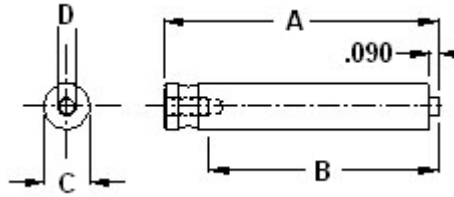

INCH

Part #	Fastener Size	Dim. A in	Dim. B in	Dia. C in	Dia. D in
10-00271	2-56	1.5	1.0	.500	.066
10-00272	4-40	1.5	1.0	.500	.085
10-00273	6-32	1.5	1.0	.500	.102
10-00274	8-32	1.5	1.0	.500	.132
10-00275	10-32	1.5	1.0	.500	.154
10-00276	1/4-20	1.5	1.0	.500	.196
10-00277	5/16-18	1.5	1.0	.500	.250
10-00304	3/8-16	1.5	1.0	.500	.306
10-00278	2-56	3.0	2.5	.500	.066
10-00279	4-40	3.0	2.5	.500	.085
10-00280	6-32	3.0	2.5	.500	.102
10-00281	8-32	3.0	2.5	.500	.132
10-00282	10-32	3.0	2.5	.500	.154
10-00283	1/4-20	3.0	2.5	.500	.196
10-00284	5/16-18	3.0	2.5	.500	.250
10-00303	3/8-16	3.0	2.5	.500	.306

METRIC

Part #	Fastener Size	Dim. A mm	Dim. B mm	Dia. C mm	Dia. D mm
10-00285	M2.5	38.1	25.4	12.7	1.95
10-00286	M3	38.1	25.4	12.7	2.36
10-00287	M3.5	38.1	25.4	12.7	2.76
10-00288	M4	38.1	25.4	12.7	3.17
10-00289	M5	38.1	25.4	12.7	4.06
10-00290	M6	38.1	25.4	12.7	4.87
10-00291	M8	38.1	25.4	12.7	6.65
10-00302	M10	38.1	25.4	12.7	8.33
10-00306	M12	38.1	25.4	12.7	10.05
10-00292	M2.5	76.2	63.5	12.7	1.95
10-00293	M3	76.2	63.5	12.7	2.36
10-00294	M3.5	76.2	63.5	12.7	2.76
10-00295	M4	76.2	63.5	12.7	3.17
10-00296	M5	76.2	63.5	12.7	4.06
10-00297	M6	76.2	63.5	12.7	4.87
10-00298	M8	76.2	63.5	12.7	6.65
10-00301	M10	76.2	63.5	12.7	8.33
10-00305	M12	76.2	63.5	12.7	10.05

FH, FHS, FHA, CH, CHS, CHA

Stud Tooling, Inch

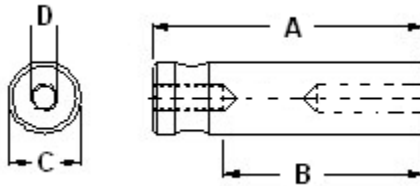

INCH

Part #	Fastener Size	Dim. A in	Dim. B in	Dia. C in	Dia. D in
H-103-2S	2-56	1.50	1.00	.500	.087
H-103-4S	4-40	1.50	1.00	.500	.113
H-103-6S	6-32	1.50	1.00	.500	.140
H-103-8S	8-32	1.50	1.00	.500	.166
H-103-10S	10-32	1.50	1.00	.500	.193
H-103-04S	1/4-20	1.50	1.00	.500	.250
H-103-05S	5/16-18	2.25	1.75	.750	.313
H-103-06S	3/8-16	2.25	1.75	.750	.377
H-103-00S	Blank	1.50	1.00	.500	
H-103-062S	Blank	1.50	1.00	.625	
H-103-075S	Blank	1.50	1.00	.750	
H-103-2L	2-56	3.00	2.50	.500	.087
H-103-4L	4-40	3.00	2.50	.500	.113
H-103-6L	6-32	3.00	2.50	.500	.140
H-103-8L	8-32	3.00	2.50	.500	.166
H-103-10L	10-32	3.00	2.50	.500	.193
H-103-04L	1/4-20	3.00	2.50	.500	.250
H-103-05L	5/16-18	3.00	2.50	.750	.313
H-103-06L	3/8-16	3.00	2.50	.750	.377
H-103-00L	Blank	3.00	2.50	.500	
H-103-062L	Blank	3.00	2.50	.625	
H-103-075L	Blank	3.00	2.50	.750	

Notes:

1. Maximum Length Studs
 - a. The **maximum** length stud for H-103-05L is 1 3/4 in.
 - b. The **maximum** length stud for H-103-06L is 1 3/4 in.
 - c. The **maximum** length stud for all other tools is 1 1/4 in.

Caution: When using short tooling (1.5 in.) and the threaded hole in the bottom of the tool is used to secure it in the lower tool holder, make sure the cap screw used to secure the tool provides adequate clearance for the stud.

2. Blanks are not hardened and do not have a black oxide finish.

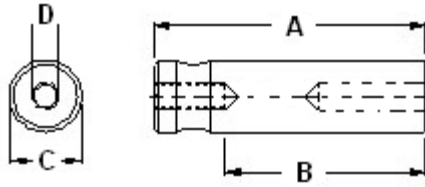

FH, FHS, FHA, CH, CHS, CHA

Stud Tooling, Metric

METRIC

Part #	Fastener Size	Dim. A mm	Dim. B mm	Dia. C mm	Dia. D mm
H-103-M2.5S	M2.5	38.1	25.4	12.7	2.56
H-103-M3S	M3	38.1	25.4	12.7	3.07
H-103-M3.5S	M3.5	38.1	25.4	12.7	3.55
H-103-M4S	M4	38.1	25.4	12.7	4.06
H-103-M5S	M5	38.1	25.4	12.7	5.05
H-103-M6S	M6	38.1	25.4	12.7	6.04
H-103-M8S	M8	57.2	44.5	19.1	8.02
H-103-M10S	M10	57.2	44.5	19.1	10.03
H-103-00S	Blank	38.1	25.4	12.7	
H-103-062S	Blank	38.1	25.4	15.9	
H-103-075S	Blank	38.1	25.4	19.1	
H-103-M2.5L	M2.5	80.0	63.5	12.7	2.56
H-103-M3L	M3	80.0	63.5	12.7	3.07
H-103-M3.5L	M3.5	80.0	63.5	12.7	3.55
H-103-M4L	M4	80.0	63.5	12.7	4.06
H-103-M5L	M5	80.0	63.5	12.7	5.05
H-103-M6L	M6	80.0	63.5	12.7	6.04
H-103-M8L	M8	80.0	63.5	19.1	8.02
H-103-M10L	M10	80.0	63.5	19.1	10.03
H-103-00L	Blank	76.2	63.5	12.7	
H-103-062L	Blank	76.2	63.5	15.9	
H-103-075L	Blank	76.2	63.5	19.1	

Notes:

1. Maximum Length Studs

- a. The maximum length stud for H-103-M8S is 25 mm.
- b. The maximum length stud for H-103-M8L is 38 mm.
- c. The maximum length stud for all short tools is 40 mm.

Caution: When using short tooling (40 mm) and the threaded hole in the bottom of the tool is used to secure it in the lower tool holder, make sure the cap screw used to secure the tool provides adequate clearance for the stud.

2. Blanks are not hardened and do not have a black oxide finish.

S, SS, CLS, CLSS, C, CS

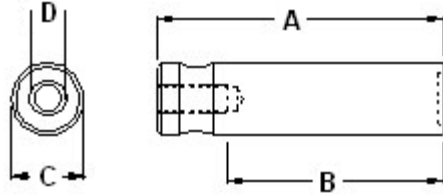

**Nut Tooling
Pocket Style Inch**

INCH

Part #	Fastener Size	Dim. A in	Dim. B in	Dia. C in	Dia. D in
H-101-2-4/M3S	2-56 & 4-40	1.5	1.0	.500	.265
H-101-6/M3.5S	6-32	1.5	1.0	.500	.295
H-101-8/M4S	8-32	1.5	1.0	.500	.325
H-101-10/M5S	10-32	1.5	1.0	.500	.355
H-101-04/M6S	1/4-20	1.5	1.0	.500	.450
H-101-05/M8S	5/16-18	1.5	1.0	.625	.515
H-101-06S	3/8-16	1.5	1.0	.750	.593
H-101-2-4/M3L	2-56 & 4-40	3.0	2.5	.500	.265
H-101-6/M3.5L	6-32	3.0	2.5	.500	.295
H-101-8/M4L	8-32	3.0	2.5	.500	.325
H-101-10/M5L	10-32	3.0	2.5	.500	.355
H-101-04/M6L	1/4-20	3.0	2.5	.500	.450
H-101-05/M8L	5/16-18	3.0	2.5	.625	.515
H-101-06L	3/8-16	3.0	2.5	.750	.593

**Nut Tooling
Pocket Style Metric**

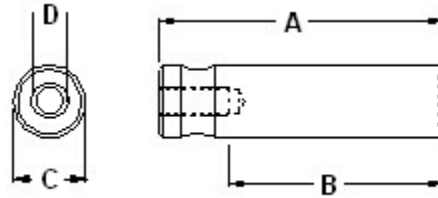

METRIC

Part #	Fastener Size	Dim. A mm	Dim. B mm	Dia. C mm	Dia. D mm
H-101-2-4/M3S	M2,M2.5,M3	38.1	25.4	12.70	6.73
H-101-6/M3.5S	M3.5	38.1	25.4	12.70	7.49
H-101-8/M4S	M4	38.1	25.4	12.70	8.25
H-101-10/M5S	M5	38.1	25.4	12.70	9.01
H-101-04/M6S	M6	38.1	25.4	12.70	11.43
H-101-05/M8S	M8	38.1	25.4	15.88	13.08
H-101-2-4/M3L	M2,M2.5,M3	76.2	63.5	12.70	6.73
H-101-6/M3.5L	M3.5	76.2	63.5	12.70	7.49
H-101-8/M4L	M4	76.2	63.5	12.70	8.25
H-101-10/M5L	M5	76.2	63.5	12.70	9.01
H-101-04/M6L	M6	76.2	63.5	12.70	11.43
H-101-05/M8L	M8	76.2	63.5	15.88	13.08

Note: M10 nut tools are available as custom tooling

INCH/METRIC

Part #	Dim. A in./mm	Dim. B in./mm	Dia. C in./mm
H-108-0018S	1.5/38.1	1.0/25.4	.25/6.4
H-108-0019S	1.5/38.1	1.0/25.4	.50/12.7
H-108-0020S	1.5/38.1	1.0/25.4	1.00/25.4
H-108-0018L	3.0/76.2	2.5/63.5	.25/6.4
H-108-0019L	3.0/76.2	2.5/63.5	.50/12.7
H-108-0020L	3.0/76.2	2.5/63.5	1.00/25.4

Anvils

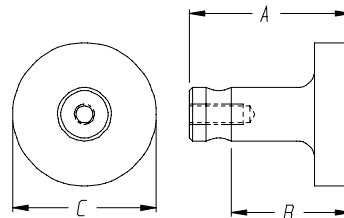

INCH/METRIC

Part #	Dim. A in./mm	Dim. B in./mm	Dia. C in./mm
H-145	2/50.8	1.25/31.8	.75/19.1

Soft Face Tool

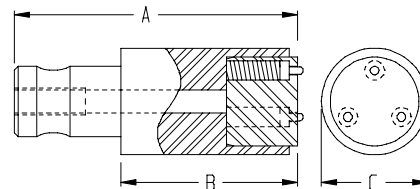

Notes:

1. This tool has an epoxy board face which is used to minimize marring of soft materials.
2. Spring loaded Continuity Pins extend above the epoxy board to permit operating in the Conductive Mode.

Adapters & Extenders

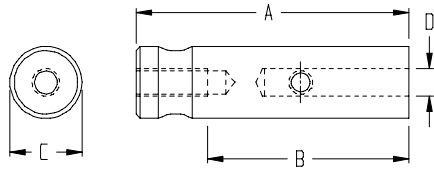

INCH/METRIC

Part #	Dim. A in./mm	Dim. B in./mm	Dia. C in./mm	Dia. D in./mm
H-110-375-2	2.0/50.8	1.5/38.1	.62/15.9	.375/9.5
H-110-500-2	2.0/50.8	1.5/38.1	.75/19.1	.500/12.7
H-110-375-3	3.0/76.2	2.5/63.5	.62/15.9	.375/9.5
H-110-500-3	3.0/76.2	2.5/63.5	.75/19.1	.500/12.7

H-110-375 tools may be used to adapt PemSert® tools for use on a Haeger machine.

H-110-500 tools may be used to extend the length of the Haeger upper and/or lower tools to insert fasteners into deep box shaped parts or shorten the stroke when using shuttle style automatic tooling.

Stud Depressor INCH

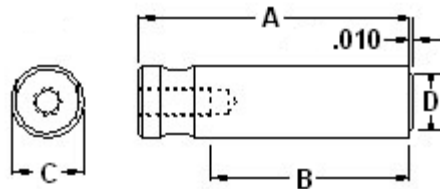

INCH

Part #	Fastener Size	Dim. A in.	Dim. B in.	Dia. C in.	Dia. D in.
H-111-2S	2-56	1.5	1.0	.50	.165
H-111-4S	4-40	1.5	1.0	.50	.180
H-111-6S	6-32	1.5	1.0	.50	.220
H-111-8S	8-32	1.5	1.0	.50	.250
H-111-10S	10-32	1.5	1.0	.50	.275
H-111-04S	1/4-20	1.5	1.0	.50	.375
H-111-2L	2-56	3.0	2.5	.50	.165
H-111-4L	4-40	3.0	2.5	.50	.180
H-111-6L	6-32	3.0	2.5	.50	.220
H-111-8L	8-32	3.0	2.5	.50	.250
H-111-10L	10-32	3.0	2.5	.50	.275
H-111-04L	1/4-20	3.0	2.5	.50	.375

Note: This tooling is used to ensure that the stud's head is inserted flush with, or recessed slightly below, the surface of the workpiece.

Stud Depressor METRIC

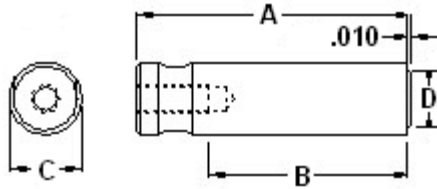

METRIC

Part #	Fastener Size	Dim. A in.	Dim. B in.	Dia. C in.	Dia. D in.
H-111-4S	M2.5 & M3	38.1	25.4	12.7	4.6
H-111-6S	M3.5	38.1	25.4	12.7	5.6
H-111-8S	M4	38.1	25.4	12.7	6.3
H-111-10S	M5	38.1	25.4	12.7	7.0
H-111-04S	M6	38.1	25.4	12.7	9.5
H-111-4L	M2.5 & M3	76.2	63.5	12.7	4.6
H-111-6L	M3.5	76.2	63.5	12.7	5.6
H-111-8L	M4	76.2	63.5	12.7	6.3
H-111-10L	M5	76.2	63.5	12.7	7.0
H-111-04L	M6	76.2	63.5	12.7	9.5

Note: This tooling is used to ensure that the stud's head is inserted flush with, or recessed slightly below, the surface of the workpiece.

S, SS, CLS, CLSS, C, CS

INCH/METRIC

Part #	Dim. A in./mm	Dim. B in./mm	Dia. C in./mm	Dim. D in./mm
H-104	1.75/44.4	1.25/31.8	1.00/25.4	.157/4.0

Rotary Nut Tooling

Fastener Size E	Fastener Size F	Fastener Size G	Fastener Size H
2-56/4-40	6-32	8-32	10-32
M2, M2.5, M3	M3.5	M4	M5

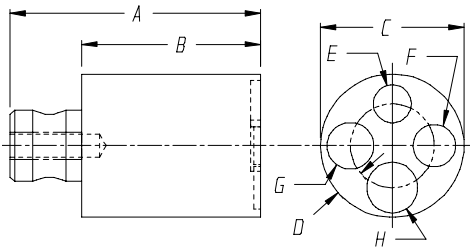

FH, FHS, FHA, CH, CHS, CHA

INCH

Part #	Dim. A in.	Dim. B in.	Dia. C in.	Dim. D in.
H-105	1.75	1.25	1.00	.157
	Fastener Size E	Fastener Size F	Fastener Size G	Fastener Size H
	2-56	4-40	6-32	8-32
	Fastener Size J			
	10-32			

Rotary Stud Tooling

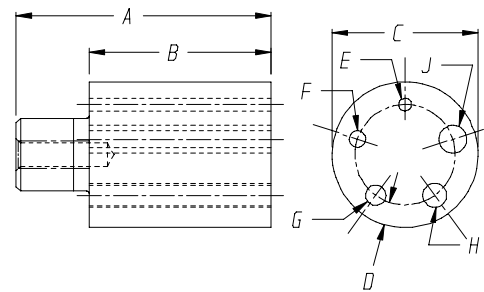

METRIC

Part #	Dim. A mm	Dim. B mm	Dia. C mm	Dim. D mm
H-105-M	44.4	31.8	25.4	4.0
	Fastener Size E	Fastener Size F	Fastener Size G	Fastener Size H
	M3	M3.5	M4	M5

J-Frame Tool Holder

Part #	Description
H-167-1	J-Frame Tool Holder

Note:

1. The **Maximum Load** on the J-Frame Tool Holder is **9,000 lbs/40 kN**. This Tool Holder may be used with both inch and metric tooling.

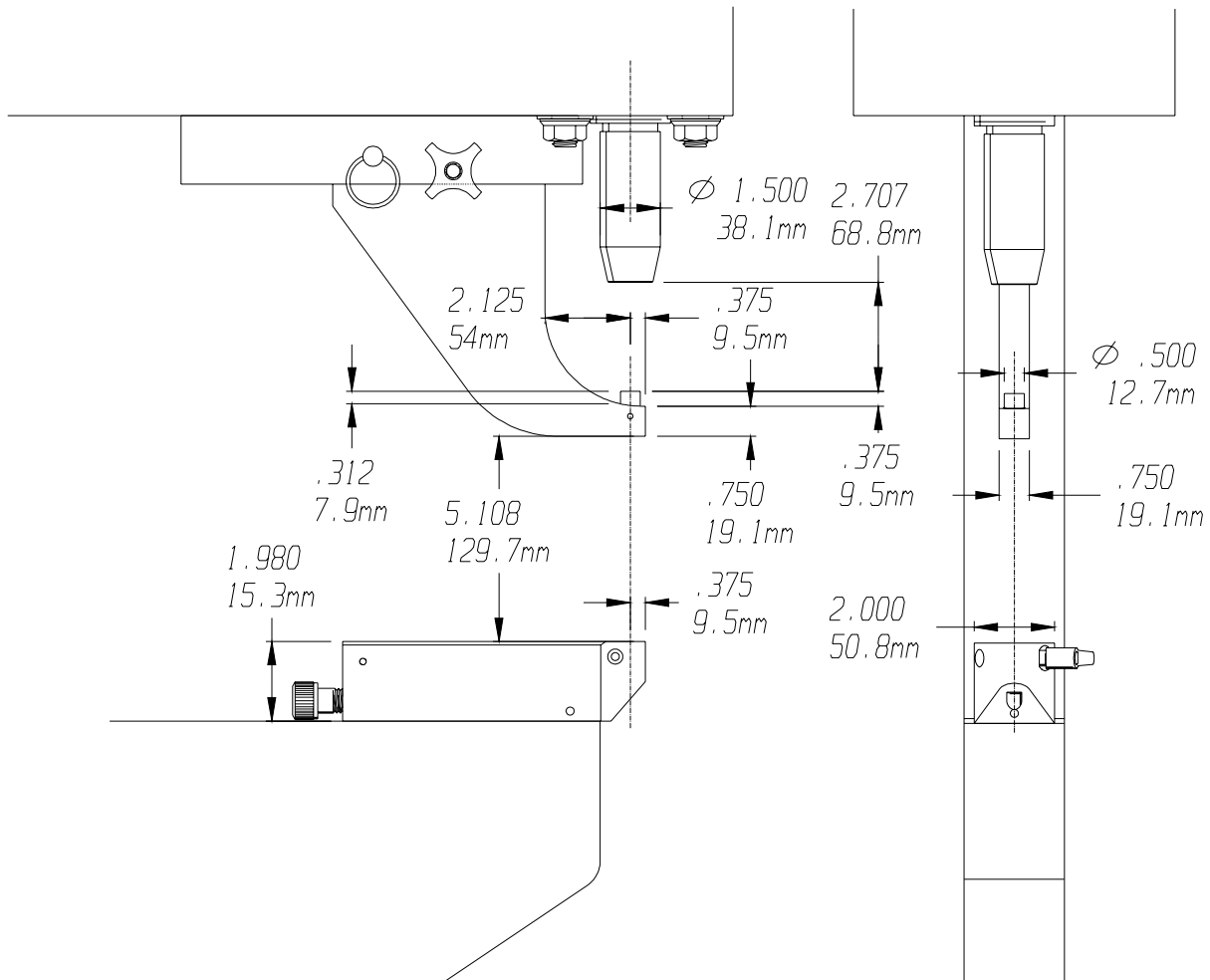
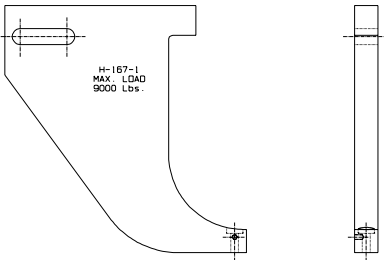

Note: These dimensions apply only to Haeger's current 618 and 824 models. For all other models, some of the dimensions may vary slightly.

S, SS, CLS, CLSS, C, CS

INCH Part#	Fastener Size	Dim. A in.	Dim. B in.	Dia. C in.	Offset D in.	Dia. E in.
H-100-2-4/M3	2-56 & 4-40	.73	.312	.50	.067	.265
H-100-6/M3.5	6-32	.73	.312	.50	.052	.295
H-100-8/M4	8-32	.73	.312	.50	.037	.325
H-100-10/M5	10-32	.73	.312	.50	.022	.355
H-100-04/M6	1/4-20	.73	.312	.50	.000	.455
H-100-0	Flat Anvil	.73	.312	.50	n/a	n/a
H-100-0-B	Blank	.73	.312	.50	n/a	n/a

Nut Tooling Pocket Style

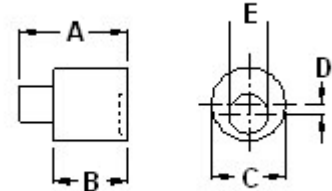

METRIC Part#	Fastener Size	Dim. A in.	Dim. B in.	Dia. C in.	Offset D in.	Dia. E in.
H-100-2-4/M3	M2, M2.5, M3	18.5	7.9	12.7	1.7	6.73
H-100-6/M3.5	M3.5	18.5	7.9	12.7	1.3	7.49
H-100-8/M4	M4	18.5	7.9	12.7	.9	8.25
H-100-10/M5	M5	18.5	7.9	12.7	.6	9.01
H-100-04/M6	M6	18.5	7.9	12.7	.0	11.55
H-100-0	Flat Anvil	18.5	7.9	12.7	n/a	n/a
H-100-0-B	Blank	18.5	7.9	12.7	n/a	n/a

Note: These tools may also be used in the Square Tip Tool Holder, H-170-1.

INCH Part#	Fastener Size	Dim. A in.	Dim. B in.	Dia. C in.	Offset D in.	Dia. E in.
10-00650	2-56	.73	.312	.50	.067	.065
10-00651	4-40	.73	.312	.50	.067	.085
10-00652	6-32	.73	.312	.50	.052	.102
10-00653	8-32	.73	.312	.50	.037	.132
10-00654	10-32	.73	.312	.50	.022	.154
10-00655	1/4-20	.73	.312	.50	.000	.196

Nut Tooling Pin Style

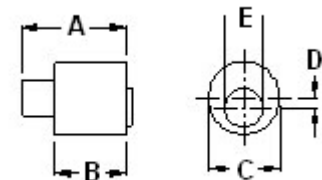

METRIC Part#	Fastener Size	Dim. A in.	Dim. B in.	Dia. C in.	Offset D in.	Dia. E in.
10-00656	M2.5	18.5	7.9	12.7	1.7	1.95
10-00657	M3	18.5	7.9	12.7	1.7	2.36
10-00658	M3.5	18.5	7.9	12.7	1.3	2.76
10-00659	M4	18.5	7.9	12.7	.9	3.17
10-00660	M5	18.5	7.9	12.7	.6	4.06
10-00661	M6	18.5	7.9	12.7	.0	4.87

Note: These tools may also be used in the Square Tip Tool Holder, H-170-1.

J-Frame Tool Holder

Part #	Description
H-167-1	J-Frame Tool Holder

Note:

1. The **Maximum Load** on the J-Frame Tool Holder is **9,000 lbs/40 kN**. This Tool Holder may be used with both inch and metric tooling.

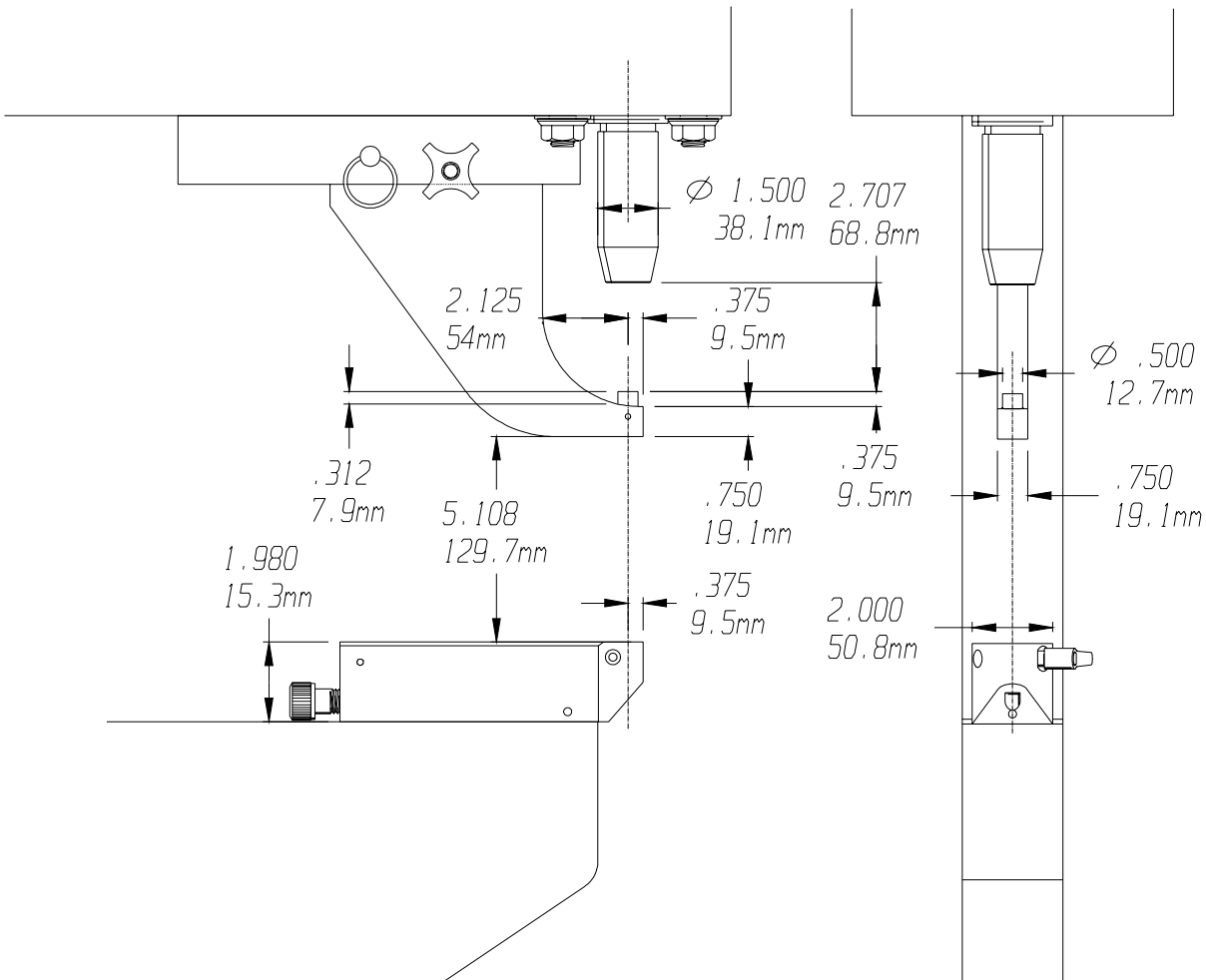
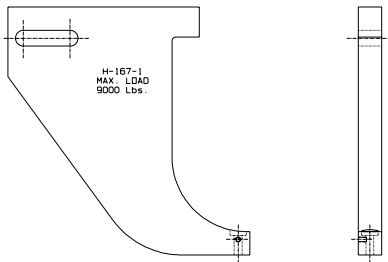

Note: These dimensions apply only to Haeger's current 618 and 824 models. For all other models, some of the dimensions may vary slightly.

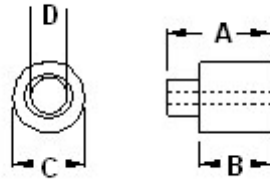

J-Frame Stud Tooling

INCH

Part #	Fastener Size	Dim. A in	Dim. B in	Dia. C in	Dia. D in
H-102-2	2-56	.73	.312	.500	.087
H-102-4	4-40	.73	.312	.500	.113
H-102-6	6-32	.73	.312	.500	.140
H-102-8	8-32	.73	.312	.500	.166
H-102-10	10-32	.73	.312	.500	.193

Note: These tools may also be used in the Square Tip Tool Holder, H-170-1.

METRIC

Part #	Fastener Size	Dim. A mm	Dim. B mm	Dia. C mm	Dia. D mm
H-102-M3	M2.5,M3	18.5	7.9	12.7	3.07
H-102-M3.5	M3.5	18.5	7.9	12.7	3.55
H-102-M4	M4	18.5	7.9	12.7	4.06
H-102-M5	M5	18.5	7.9	12.7	5.05

Note: These tools may also be used in the Square Tip Tool Holder, H-170-1.

SP Nut Upper Tool

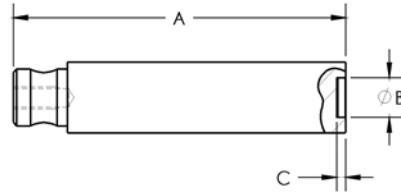

INCH/METRIC

Part #	Fastener Size	Dim. A in.	Dim. B in.	Dia. C in.
H-183-4/M3-S	4-40 & M3	1.50	.255	.064
H-183-6/M3.5-S	6-32 & M3.5	1.50	.286	.064
H-183-8/M4-S	8-32 & M4	1.50	.317	.082
H-183-10/M5-S	10-32 & M5	1.50	.348	.082
H-183-04/M6-S	1/4-20 & M6	1.50	.443	.163
H-183-4/M3-L	4-40 & M3	3.00	.255	.064
H-183-6/M3.5-L	6-32 & M3.5	3.00	.286	.064
H-183-8/M4-L	8-32 & M4	3.00	.317	.082
H-183-10/M5-L	10-32 & M5	3.00	.348	.082
H-183-04/M6-L	1/4-20 & M6	3.00	.443	.163

TD Lower Tool

INCH

Part #	Fastener	Dim. A in.	Dim. B in.	Dia. C in.	Dia. D in.	Dia. E in.
14-01827-S	TD-40-4	.151	.251	.500	.160	1.50
14-01828-S	TD-60-6	.214	.313	.625	.190	1.50
14-01829-S	TD-175-12	.401	.501	1.00	.295	1.75
14-01827-L	TD-40-4	.151	.251	.500	.160	3.00
14-01828-L	TD-60-6	.214	.313	.625	.190	3.00
14-01829-L	TD-175-12	.401	.501	1.00	.295	3.00

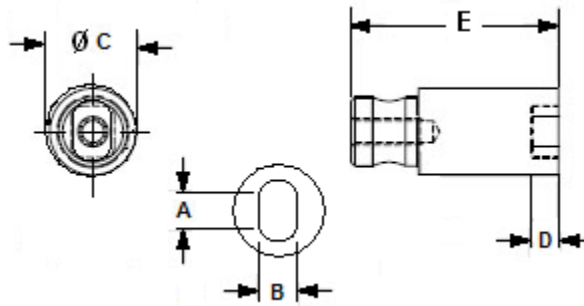

Right Angle Fastener Tool

INCH						
Part #	Fastener Size	Dim. A in.	Dim. B in.	Dia. C in.	Dia. D in.	Dia. E in.
H-180-440-S	RAS 4-40	.257	.313	.251	.625	1.50
H-180-632-S	RAS 6-32	.307	.376	.313	.750	1.50
H-180-832-S	RAS 8-32	.357	.407	.376	.875	1.50
H-180-M3-S	RAS M3	.257	.316	.237	.750	1.50
H-180-M4-S	RAS M4	.357	.395	.355	.875	1.50
H-180-440-L	RAS 4-40	.257	.313	.251	.625	3.00
H-180-632-L	RAS 6-32	.307	.376	.313	.750	3.00
H-180-832-L	RAS 8-32	.357	.407	.376	.875	3.00
H-180-M3-L	RAS M3	.257	.316	.237	.750	3.00
H-180-M4-L	RAS M4	.357	.395	.355	.875	3.00

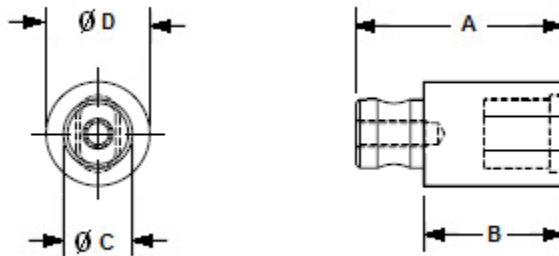

FH4 Stud Coining Ring Tool

INCH

Part #	Fastener Size	Dim. A in.	Dim. B in.	Dia. C in.	Dia. D in.	Dia. E in.	Dia. F in.
H-181-4S	FH4 4-40	.113	.144	.174	.010	.500	1.50
H-181-6S	FH4 6-32	.140	.170	.200	.010	.500	1.50
H-181-8S	FH4 8-32	.166	.202	.236	.010	.500	1.50
H-181-10S	FH4 10-32	.191	.235	.275	.010	.500	1.50
H-181-04S	FH4 1/4-20	.252	.324	.360	.020	.500	1.50
H-181-4L	FH4 4-40	.113	.144	.174	.010	.500	3.00
H-181-6L	FH4 6-32	.140	.170	.200	.010	.500	3.00
H-181-8L	FH4 8-32	.166	.202	.236	.010	.500	3.00
H-181-10L	FH4 10-32	.191	.235	.275	.010	.500	3.00
H-181-04L	FH4 1/4-20	.252	.324	.360	.020	.500	3.00

METRIC

Part #	Fastener Size	Dim. A mm	Dim. B mm	Dia. C mm	Dia. D mm	Dia. E mm	Dia. F mm
H-181-M3S	FH4 M3	3.04	3.81	4.57	2.54	12.7	38.1
H-181-M4S	FH4 M4	4.03	4.95	5.81	2.54	12.7	38.1
H-181-M5S	FH4 M5	5.08	6.14	7.16	2.54	12.7	38.1
H-181-M6S	FH4 M6	6.04	7.87	8.78	5.08	12.7	38.1
H-181-M3L	FH4 M3	3.04	3.81	4.57	2.54	12.7	76.2
H-181-M4L	FH4 M4	4.03	4.95	5.81	2.54	12.7	76.2
H-181-M5L	FH4 M5	5.08	6.14	7.16	2.54	12.7	76.2
H-181-M6L	FH4 M6	6.04	7.87	8.78	5.08	12.7	76.2

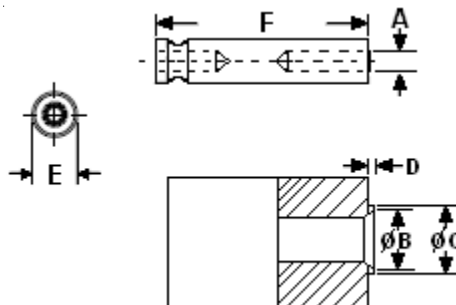

PFS2, PFC2

Panel Fastener Tooling Anvil
INCH

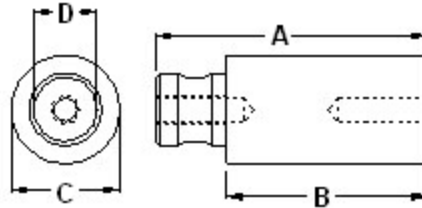

INCH

Part #	Fastener Size	Dim. A in	Dim. B in	Dia. C in	Dia. D in
H-132-4S	4-40	1.5	1.0	.625	.170
H-132-6S	6-32	1.5	1.0	.625	.187
H-132-8S	8-32	1.5	1.0	.687	.217
H-132-10S	10-32	1.5	1.0	.687	.249
H-132-04S	1/4-20	1.5	1.0	.750	.317
H-132-4L	4-40	3.0	2.5	.625	.170
H-132-6L	6-32	3.0	2.5	.625	.187
H-132-8L	8-32	3.0	2.5	.687	.217
H-132-10L	10-32	3.0	2.5	.687	.249
H-132-04L	1/4-20	3.0	2.5	.750	.317

Notes:

1. This tooling is based on the fastener thread size.
2. This tooling is used with H-144 tooling.
3. Depending on the application, these tools may be used as the punch or anvil.

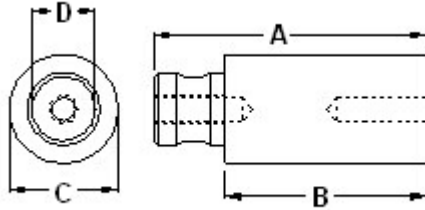

Panel Fastener Tooling Anvil
METRIC

METRIC

Part #	Fastener Size	Dim. A mm	Dim. B mm	Dia. C mm	Dia. D mm
H-132-4S	M3	38.1	25.4	15.88	4.31
H-132-8S	M4	38.1	25.4	17.45	5.51
H-132-10S	M5	38.1	25.4	17.45	6.32
H-132-04S	M6	38.1	25.4	19.04	8.05
H-132-4L	M3	76.2	63.5	15.88	4.31
H-132-8L	M4	76.2	63.5	17.45	5.51
H-132-10L	M5	76.2	63.5	17.45	6.32
H-132-04L	M6	76.2	63.5	19.04	8.05

Notes:

1. This tooling is based on the fastener thread size.
2. This tooling is used with H-144 tooling.
3. Depending on the application, these tools may be used as the punch or anvil.

Panel Fastener Tooling Punch
INCH

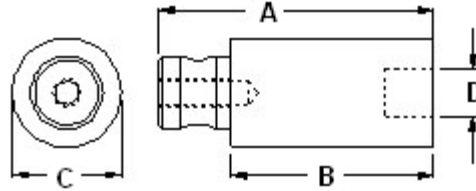

INCH

Part #	Fastener Size	Dim. A in	Dim. B in	Dia. C in	Dia. D in
H-144-4S	4-40	1.5	1.0	.750	.32
H-144-6S	6-32	1.5	1.0	.750	.35
H-144-8S	8-32	1.5	1.0	.750	.39
H-144-10S	10-32	1.5	1.0	.750	.42
H-144-04S	1/4-20	1.5	1.0	.750	.48
H-144-4L	4-40	3.0	2.5	.750	.32
H-144-6L	6-32	3.0	2.5	.750	.35
H-144-8L	8-32	3.0	2.5	.750	.39
H-144-10L	10-32	3.0	2.5	.750	.42
H-144-04L	1/4-20	3.0	2.5	.750	.48

Notes:

1. This tooling is based on the fastener thread size.
2. This tooling is used with H-132 tooling.
3. Depending on the application, these tools may be used as the punch or anvil.

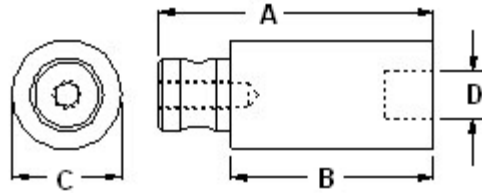

**Panel Fastener Tooling Punch
METRIC**

METRIC

Part #	Fastener Size	Dim. A mm	Dim. B mm	Dia. C mm	Dia. D mm
H-144-4S	M3	38.1	25.4	19.04	8.12
H-144-8S	M4	38.1	25.4	19.04	9.90
H-144-10S	M5	38.1	25.4	19.04	10.66
H-144-04S	M6	38.1	25.4	19.04	12.19
H-144-4L	M3	76.2	63.5	19.04	8.12
H-144-8L	M4	76.2	63.5	19.04	9.90
H-144-10L	M5	76.2	63.5	19.04	10.66
H-144-04L	M6	76.2	63.5	19.04	12.19

Notes:

1. This tooling is based on the fastener thread size.
2. This tooling is used with H-132 tooling.
3. Depending on the application, these tools may be used as the punch or anvil.

CFE, CFEO, CFEX, CFEXO, U, UL,
FE, FEX, FEO, FEOX

Miniature Nut Tooling
INCH

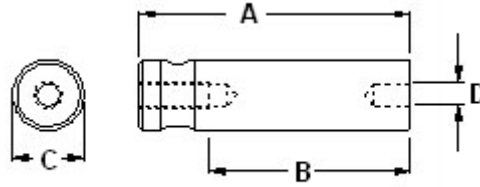

INCH Part #	Fastener Size	Dim. A in	Dim. B in	Dia. C in	Dia. D in
H-133-0S	0-80	1.5	1.0	.500	.081
H-133-1S	1-64	1.5	1.0	.500	.095
H-133-2S	2-56	1.5	1.0	.500	.109
H-133-4S	4-40	1.5	1.0	.500	.150
H-133-6S	6-32	1.5	1.0	.500	.180
H-133-8S	8-32	1.5	1.0	.500	.220
H-133-10S	10-32	1.5	1.0	.500	.250
H-133-04S	1/4-20	1.5	1.0	.500	.323
H-133-0L	0-80	3.0	2.5	.500	.081
H-133-1L	1-64	3.0	2.5	.500	.095
H-133-2L	2-56	3.0	2.5	.500	.109
H-133-4L	4-40	3.0	2.5	.500	.150
H-133-6L	6-32	3.0	2.5	.500	.180
H-133-8L	8-32	3.0	2.5	.500	.220
H-133-10L	10-32	3.0	2.5	.500	.250
H-133-04L	1/4-20	3.0	2.5	.500	.323

CFE, CFEO, CFEX, CFEXO, U, UL,
FE, FEX, FEO, FEOX

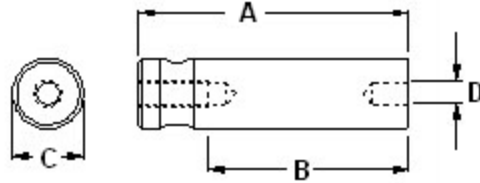

Miniature Nut Tooling
METRIC

METRIC

Part #	Fastener Size	Dim. A mm	Dim. B mm	Dia. C mm	Dia. D mm
H-133-M3S	M3	38.1	25.4	12.7	4.08
H-133-M4S	M4	38.1	25.4	12.7	5.35
H-133-M5S	M5	38.1	25.4	12.7	6.60
H-133-M6S	M6	38.1	25.4	12.7	7.84
H-133-M3L	M3	76.2	63.5	12.7	4.08
H-133-M4L	M4	76.2	63.5	12.7	5.35
H-133-M5L	M5	76.2	63.5	12.7	6.60
H-133-M6L	M6	76.2	63.5	12.7	7.84

CFAS, CFAC, AS, AC, LAS, LAC

Floating Nut Tooling
INCH

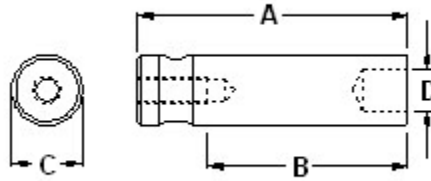

INCH

Part #	Fastener Size	Dim. A in	Dim. B in	Dia. C in	Dia. D in
H-131-4S	4-40	1.5	1.0	.500	.300
H-131-6S	6-32	1.5	1.0	.500	.340
H-131-8S	8-32	1.5	1.0	.500	.375
H-131-10S	10-32	1.5	1.0	.625	.415
H-131-04S	1/4-20	1.5	1.0	.750	.520
H-131-4L	4-40	3.0	2.5	.500	.300
H-131-6L	6-32	3.0	2.5	.500	.340
H-131-8L	8-32	3.0	2.5	.500	.375
H-131-10L	10-32	3.0	2.5	.625	.415
H-131-04L	1/4-20	3.0	2.5	.750	.520

CFAS, CFAC, AS, AC, LAS, LAC

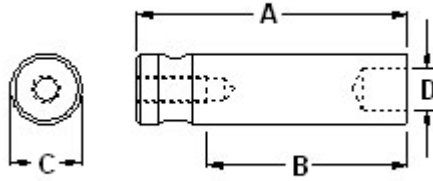

Floating Nut Tooling
 METRIC

METRIC

Part #	Fastener Size	Dim. A mm	Dim. B mm	Dia. C mm	Dia. D mm
H-131-4S	M3	38.1	25.4	12.7	7.62
H-131-8S	M4	38.1	25.4	12.7	9.52
H-131-10S	M5	38.1	25.4	15.87	10.54
H-131-04S	M6	38.1	25.4	19.05	13.20
H-131-4L	M3	76.2	63.5	12.7	7.62
H-131-8L	M4	76.2	63.5	12.7	9.52
H-131-10L	M5	76.2	63.5	15.87	10.54
H-131-04L	M6	76.2	63.5	19.05	13.20

LK, LKA, LKS

Self-Locking Nut Tooling

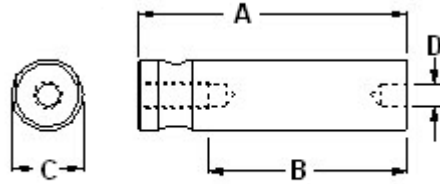

INCH

Part #	Fastener Size	Dim. A in	Dim. B in	Dia. C in	Dia. D in
H-130-2S	2-56	1.5	1.0	.500	.170
H-130-3S	3-48	1.5	1.0	.500	.180
H-130-4S	4-40	1.5	1.0	.500	.190
H-130-6S	6-32	1.5	1.0	.500	.225
H-130-8S	8-32	1.5	1.0	.500	.255
H-130-10S	10-32	1.5	1.0	.500	.290
H-130-2L	2-56	3.0	2.5	.500	.170
H-130-3L	3-48	3.0	2.5	.500	.180
H-130-4L	4-40	3.0	2.5	.500	.190
H-130-6L	6-32	3.0	2.5	.500	.225
H-130-8L	8-32	3.0	2.5	.500	.255
H-130-10L	10-32	3.0	2.5	.500	.290

METRIC

Part #	Fastener Size	Dim. A mm	Dim. B mm	Dia. C mm	Dia. D mm
H-130-2S	M3	38.1	25.4	12.7	4.95
H-130-3S	M4	38.1	25.4	12.7	6.32
H-130-4S	M5	38.1	25.4	12.7	7.51
H-130-2L	M3	76.2	63.5	12.7	4.95
H-130-3L	M4	76.2	63.5	12.7	6.32
H-130-4L	M5	76.2	63.5	12.7	7.51

CPL, CPLC

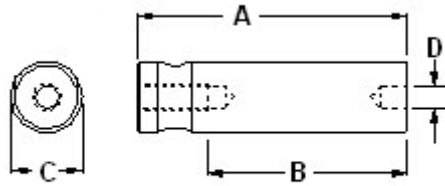

Hex Self-Locking
Nut Tooling

INCH

Part #	Fastener Size	Dim. A in	Dim. B in	Dia. C in	Dia. D in
H-134-4S	4-40	1.5	1.0	.500	.221
H-134-6S	6-32	1.5	1.0	.500	.251
H-134-8S	8-32	1.5	1.0	.500	.283
H-134-10S	10-32	1.5	1.0	.500	.297
H-134-4L	4-40	3.0	2.5	.500	.221
H-134-6L	6-32	3.0	2.5	.500	.251
H-134-8L	8-32	3.0	2.5	.500	.283
H-134-10L	10-32	3.0	2.5	.500	.297

METRIC

Part #	Fastener Size	Dim. A mm	Dim. B mm	Dia. C mm	Dia. D mm
H-134-4S	M3	38.1	25.4	12.7	5.61
H-134-8S	M4	38.1	25.4	12.7	7.18
H-134-10S	M5	38.1	25.4	12.7	7.54
H-134-4L	M3	76.2	63.5	12.7	5.61
H-134-8L	M4	76.2	63.5	12.7	7.18
H-134-10L	M5	76.2	63.5	12.7	7.54

**Retractable Screw
Assembly, No. 47,
Press in Type**

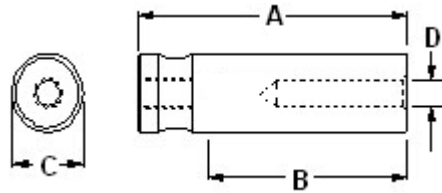

INCH/METRIC

Part #	Fastener Size	Dim. A in/mm	Dim. B in/mm	Dia. C in/mm	Dia. D in/mm
H-115-6S	6-32	1.5/38.1	1.0/25.4	.50/12.7	.146/3.70
H-115-8S	8-32	1.5/38.1	1.0/25.4	.50/12.7	.169/4.29
H-115-10S	10-32	1.5/38.1	1.0/25.4	.63/15.9	.205/5.20
H-115-04S	1/4-20	1.5/38.1	1.0/25.4	.63/15.9	.257/6.52
H-115-6L	6-32	3.0/76.2	2.5/63.5	.50/12.7	.146/3.70
H-115-8L	8-32	3.0/76.2	2.5/63.5	.50/12.7	.169/4.29
H-115-10L	10-32	3.0/76.2	2.5/63.5	.63/15.9	.205/5.20
H-115-04L	1/4-20	3.0/76.2	2.5/63.5	.63/15.9	.257/6.52

**Retractable Screw
Assembly, No. 47,
Flare Type**

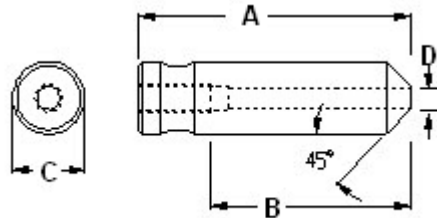

INCH/METRIC

Part #	Fastener Size	Dim. A in/mm	Dim. B in/mm	Dia. C in/mm	Dia. D in/mm
H-117-4S	4-40	1.5/38.1	1.0/25.4	.50/12.7	.126/3.20
H-117-6S	6-32	1.5/38.1	1.0/25.4	.50/12.7	.146/3.70
H-117-8S	8-32	1.5/38.1	1.0/25.4	.50/12.7	.172/4.36
H-117-10S	10-32	1.5/38.1	1.0/25.4	.50/12.7	.197/5.00
H-117-04S	1/4-20	1.5/38.1	1.0/25.4	.50/12.7	.263/6.68
H-117-4L	4-40	3.0/76.2	2.5/63.5	.50/12.7	.126/3.20
H-117-6L	6-32	3.0/76.2	2.5/63.5	.50/12.7	.146/3.70
H-117-8L	8-32	3.0/76.2	2.5/63.5	.50/12.7	.172/4.36
H-117-10L	10-32	3.0/76.2	2.5/63.5	.50/12.7	.197/5.00
H-117-04L	1/4-20	3.0/76.2	2.5-63.5	.50/12.7	.263/6.68

Note: These tools are used with H-116

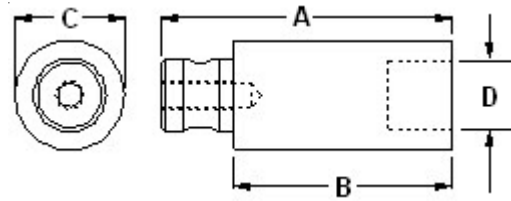

**Retractable Screw
Assembly, No. 47
Back-up Tooling**

INCH/METRIC

Part #	Fastener Size	Dim. A in/mm	Dim. B in/mm	Dia. C in/mm	Dia. D in/mm
H-116-4S	4-40	1.5/38.1	1.0/25.4	.75/19.1	.430/10.92
H-116-6S	6-32	1.5/38.1	1.0/25.4	.75/19.1	.469/11.91
H-116-8S	8-32	1.5/38.1	1.0/25.4	.75/19.1	.527/13.38
H-116-10S	10-32	1.5/38.1	1.0/25.4	.75/19.1	.527/13.38
H-116-04S	1/4-20	1.5/38.1	1.0/25.4	.75/19.1	.592/15.03
H-116-4L	4-40	3.0/76.2	2.5/63.5	.75/19.1	.430/10.92
H-116-6L	6-32	3.0/76.2	2.5/63.5	.75/19.1	.469/11.91
H-116-8L	8-32	3.0/76.2	2.5/63.5	.75/19.1	.527/13.38
H-116-10L	10-32	3.0/76.2	2.5/63.5	.75/19.1	.527/13.38
H-116-04L	1/4-20	3.0/76.2	2.5/63.5	.75/19.1	.592/15.03

Note: Use with both press in (H-115) and flare type (H-117)

Universal Head Solid Rivet Tooling

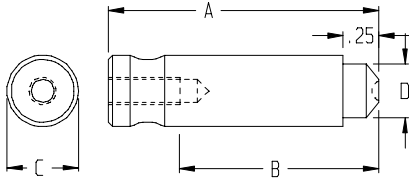

INCH/METRIC

Part Kit #	Rivet Size	Dim. A in./mm	Dim. B in./mm	Dia. C in./mm	Dia. D in./mm
H-124-062S	1/16	1.5/38.1	1.0/25.4	.50/12.7	.375/9.52
H-124-093S	3/32	1.5/38.1	1.0/25.4	.50/12.7	.375/9.52
H-124-125S	1/8	1.5/38.1	1.0/25.4	.50/12.7	.375/9.52
H-124-156S	5/32	1.5/38.1	1.0/25.4	.50/12.7	.500/12.7
H-124-187S	3/16	1.5/38.1	1.0/25.4	.50/12.7	.500/12.7
H-124-250S	1/4	1.5/38.1	1.0/25.4	.625/15.9	.625/15.9
H-124-312S	5/16	1.5/38.1	1.0/25.4	.750/19.0	.750/19.0
H-124-062L	1/16	3.0/76.2	2.5/63.5	.50/12.7	.375/9.52
H-124-093L	3/32	3.0/76.2	2.5/63.5	.50/12.7	.375/9.52
H-124-125L	1/8	3.0/76.2	2.5/63.5	.50/12.7	.375/9.52
H-124-156L	5/32	3.0/76.2	2.5/63.5	.50/12.7	.500/12.7
H-124-187L	3/16	3.0/76.2	2.5/63.5	.50/12.7	.500/12.7
H-124-250L	1/4	3.0/76.2	2.5/63.5	.625/15.9	.625/15.9
H-124-312L	5/16	3.0/76.2	2.5/63.5	.750/19.0	.750/19.0

Note: These tools are used with H-126

Part Kit #	Body	Head	Hanson Part Number
H-124-062S	H-141-50S	H-143-062S	CA2002-01
H-124-062L	H-141-50L	H-143-062L	CA2002-01
H-124-093S	H-141-50S	H-143-093S	CA2002-1
H-124-093L	H-141-50L	H-143-093L	CA2002-1
H-124-125S	H-141-50S	H-143-125S	CA2002-8
H-124-125L	H-141-50L	H-143-125L	CA2002-8
H-124-156S	H-141-50S	H-143-156S	CA2002-15
H-124-156L	H-141-50L	H-143-156L	CA2002-15
H-124-187S	H-141-50S	H-143-187S	CA2002-22
H-124-187L	H-141-50L	H-143-187L	CA2002-22
H-124-250S	H-141-62S	H-143-250S	CA2002-29
H-124-250L	H-141-62L	H-143-250L	CA2002-29
H-124-312S	H-141-75S	H-143-312S	CA2002-37
H-124-312L	H-141-75L	H-143-312L	CA2002-37

INCH/METRIC

Part #	Rivet Size	Dim. A in./mm	Dim. B in./mm	Dia. C in./mm	Dia. D in./mm
H-125-062S	1/16	1.5/38.1	1.0/25.4	.50/12.7	.375/9.52
H-125-093S	3/32	1.5/38.1	1.0/25.4	.50/12.7	.375/9.52
H-125-125S	1/8	1.5/38.1	1.0/25.4	.50/12.7	.375/9.52
H-125-156S	5/32	1.5/38.1	1.0/25.4	.50/12.7	.500/12.7
H-125-187S	3/16	1.5/38.1	1.0/25.4	.50/12.7	.500/12.7
H-125-250S	1/4	1.5/38.1	1.0/25.4	.625/15.9	.625/15.9
H-125-312S	5/16	1.5/38.1	1.0/25.4	.750/19.0	.750/19.0
H-125-062L	1/16	3.0/76.2	2.5/63.5	.50/12.7	.375/9.52
H-125-093L	3/32	3.0/76.2	2.5/63.5	.50/12.7	.375/9.52
H-125-125L	1/8	3.0/76.2	2.5/63.5	.50/12.7	.375/9.52
H-125-156L	5/32	3.0/76.2	2.5/63.5	.50/12.7	.500/12.7
H-125-187L	3/16	3.0/76.2	2.5/63.5	.50/12.7	.500/12.7
H-125-250L	1/4	3.0/76.2	2.5/63.5	.625/15.9	.625/15.9
H-125-312L	5/16	3.0/76.2	2.5/63.5	.750/19.0	.750/19.0

Round Head Solid Rivet Tooling

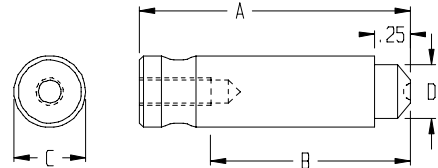

Note: These tools are used with H-126

Part Kit #	Body	Head	Hanson Part Number
H-125-062S	H-141-50S	H-140-062S	CA2000-01
H-125-062L	H-141-50L	H-140-062L	CA2000-01
H-125-093S	H-141-50S	H-140-093S	CA2000-1
H-125-093L	H-141-50L	H-140-093L	CA2000-1
H-125-125S	H-141-50S	H-140-125S	CA2000-8
H-125-125L	H-141-50L	H-140-125L	CA2000-8
H-125-156S	H-141-50S	H-140-156S	CA2000-15
H-125-156L	H-141-50L	H-140-156L	CA2000-15
H-125-187S	H-141-50S	H-140-187S	CA2000-22
H-125-187L	H-141-50L	H-140-187L	CA2000-22
H-125-250S	H-141-62S	H-140-250S	CA2000-29
H-125-250L	H-141-62L	H-140-250L	CA2000-29
H-125-312S	H-141-75S	H-140-312S	CA2000-37
H-125-312L	H-141-75L	H-140-312L	CA2000-37

Rivets

Manual Tooling Catalog

Tubular Roll Rivet Tooling

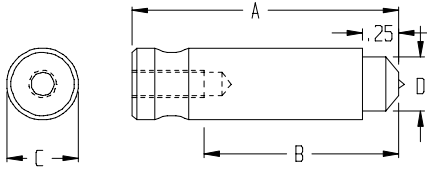

INCH/METRIC

Part #	Rivet Size	Dim. A in./mm	Dim. B in./mm	Dia. C in./mm	Dia. D in./mm
H-127-062S	1/16	1.5/38.1	1.0/25.4	.50/12.7	.375/9.52
H-127-093S	3/32	1.5/38.1	1.0/25.4	.50/12.7	.375/9.52
H-127-125S	1/8	1.5/38.1	1.0/25.4	.50/12.7	.375/9.52
H-127-156S	5/32	1.5/38.1	1.0/25.4	.50/12.7	.500/12.7
H-127-187S	3/16	1.5/38.1	1.0/25.4	.50/12.7	.500/12.7
H-127-250S	1/4	1.5/38.1	1.0/25.4	.625/15.9	.625/15.9
H-127-312S	5/16	1.5/38.1	1.0/25.4	.750/19.0	.750/19.0
H-127-062L	1/16	3.0/76.2	2.5/63.5	.50/12.7	.375/9.52
H-127-093L	3/32	3.0/76.2	2.5/63.5	.50/12.7	.375/9.52
H-127-125L	1/8	3.0/76.2	2.5/63.5	.50/12.7	.375/9.52
H-127-156L	5/32	3.0/76.2	2.5/63.5	.50/12.7	.500/12.7
H-127-187L	3/16	3.0/76.2	2.5/63.5	.50/12.7	.500/12.7
H-127-250L	1/4	3.0/76.2	2.5/63.5	.625/15.9	.625/15.9
H-127-312L	5/16	3.0/76.2	2.5/63.5	.750/19.0	.750/19.0

Note: These tools are used with H-128

Part Kit #	Body	Head	Hanson Part Number
H-127-062S	H-141-50S	H-138-062S	CA2005-01
H-127-062L	H-141-50L	H-138-062L	CA2005-01
H-127-093S	H-141-50S	H-138-093S	CA2005-1
H-127-093L	H-141-50L	H-138-093L	CA2005-1
H-127-125S	H-141-50S	H-138-125S	CA2005-8
H-127-125L	H-141-50L	H-138-125L	CA2005-8
H-127-156S	H-141-50S	H-138-156S	CA2005-15
H-127-156L	H-141-50L	H-138-156L	CA2005-15
H-127-187S	H-141-50S	H-138-187S	CA2005-22
H-127-187L	H-141-50L	H-138-187L	CA2005-22
H-127-250S	H-141-62S	H-138-250S	CA2005-29
H-127-250L	H-141-62L	H-138-250L	CA2005-29
H-127-312S	H-141-75S	H-138-312S	CA2005-37
H-127-312L	H-141-75L	H-138-312L	CA2005-37

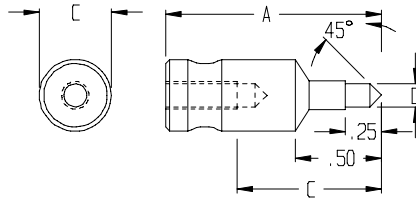

Tubular Flare Rivet Tooling

INCH/METRIC

Part #	Rivet Size	Dim. A in./mm	Dim. B in./mm	Dia. C in./mm	Dia. D in./mm
H-129-062S	1/16	1.5/38.1	1.0/25.4	.50/12.7	.162/4.1
H-129-093S	3/32	1.5/38.1	1.0/25.4	.50/12.7	.162/4.1
H-129-125S	1/8	1.5/38.1	1.0/25.4	.50/12.7	.213/5.4
H-129-156S	5/32	1.5/38.1	1.0/25.4	.50/12.7	.213/5.4
H-129-187S	3/16	1.5/38.1	1.0/25.4	.50/12.7	.213/5.4
H-129-250S	1/4	1.5/38.1	1.0/25.4	.50/12.7	.264/6.7
H-129-062L	1/16	3.0/76.2	2.5/63.5	.50/12.7	.162/4.1
H-129-093L	3/32	3.0/76.2	2.5/63.5	.50/12.7	.162/4.1
H-129-125L	1/8	3.0/76.2	2.5/63.5	.50/12.7	.213/5.4
H-129-156L	5/32	3.0/76.2	2.5/63.5	.50/12.7	.213/5.4
H-129-187L	3/16	3.0/76.2	2.5/63.5	.50/12.7	.213/5.4
H-129-250L	1/4	3.0/76.2	2.5/63.5	.50/12.7	.264/6.7

Note: These tools are used with H-128

Rivets

Manual Tooling Catalog

INCH/METRIC

Part #	Rivet Size	Dim. A in./mm	Dim. B in./mm	Dia. C in./mm
H-128-062S	1/16	1.5/38.1	1.0/25.4	.50/12.7
H-128-093S	3/32	1.5/38.1	1.0/25.4	.50/12.7
H-128-125S	1/8	1.5/38.1	1.0/25.4	.50/12.7
H-128-156S	5/32	1.5/38.1	1.0/25.4	.50/12.7
H-128-187S	3/16	1.5/38.1	1.0/25.4	.50/12.7
H-128-250S	1/4	1.5/38.1	1.0/25.4	.625/15.9
H-128-312S	5/16	1.5/38.1	1.0/25.4	.750/19.0
H-128-062L	1/16	3.0/76.2	2.5/63.5	.50/12.7
H-128-093L	3/32	3.0/76.2	2.5/63.5	.50/12.7
H-128-125L	1/8	3.0/76.2	2.5/63.5	.50/12.7
H-128-156L	5/32	3.0/76.2	2.5/63.5	.50/12.7
H-128-187L	3/16	3.0/76.2	2.5/63.5	.50/12.7
H-128-250L	1/4	3.0/76.2	2.5/63.5	.625/15.9
H-128-312L	5/16	3.0/76.2	2.5/63.5	.750/19.0

**Tubular Rivet
Dolly Tooling**

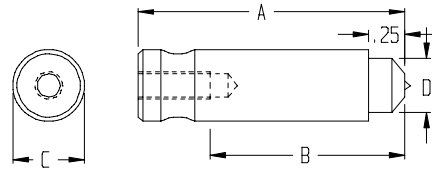

Note: These tools are used with H-127 and H-129

Part Kit #	Body	Head	Hanson Part Number
H-128-062S	H-141-50S	H-139-062S	CA2004-01
H-128-062L	H-141-50L	H-139-062L	CA2004-01
H-128-093S	H-141-50S	H-139-093S	CA2004-1
H-128-093L	H-141-50L	H-139-093L	CA2004-1
H-128-125S	H-141-50S	H-139-125S	CA2004-8
H-128-125L	H-141-50L	H-139-125L	CA2004-8
H-128-156S	H-141-50S	H-139-156S	CA2004-15
H-128-156L	H-141-50L	H-139-156L	CA2004-15
H-128-187S	H-141-50S	H-139-187S	CA2004-22
H-128-187L	H-141-50L	H-139-187L	CA2004-22
H-128-250S	H-141-62S	H-139-250S	CA2004-29
H-128-250L	H-141-62L	H-139-250L	CA2004-29
H-128-312S	H-141-75S	H-139-312S	CA2004-37
H-128-312L	H-141-75L	H-139-312L	CA2004-37

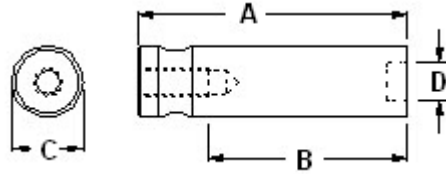

Buck Tooling

INCH/METRIC

Part #	Fastener Size	Dim. A in/mm	Dim. B in/mm	Dia. C in/mm	Dia. D in/mm
H-126-062S	1/16	1.5/38.1	1.0/25.4	.50/12.7	.125/3.17
H-126-093S	3/32	1.5/38.1	1.0/25.4	.50/12.7	.187/4.74
H-126-125S	1/8	1.5/38.1	1.0/25.4	.50/12.7	.250/6.35
H-126-156S	5/32	1.5/38.1	1.0/25.4	.50/12.7	.312/7.92
H-126-187S	3/16	1.5/38.1	1.0/25.4	.75/19.0	.375/9.52
H-126-250S	1/4	1.5/38.1	1.0/25.4	.75/19.0	.500/12.70
H-126-312S	5/16	1.5/38.1	1.0/25.4	.75/19.0	.625/15.87
H-126-062L	1/16	3.0/76.2	2.5/63.5	.50/12.7	.125/3.17
H-126-093L	3/32	3.0/76.2	2.5/63.5	.50/12.7	.187/4.74
H-126-125L	1/8	3.0/76.2	2.5/63.5	.50/12.7	.250/6.35
H-126-156L	5/32	3.0/76.2	2.5/63.5	.50/12.7	.312/7.92
H-126-187L	3/16	3.0/76.2	2.5/63.5	.75/19.0	.375/9.52
H-126-250L	1/4	3.0/76.2	2.5/63.5	.75/19.0	.500/12.70
H-126-312L	5/16	3.0/76.2	2.5/63.5	.75/19.0	.625/15.87

Note: These tools are used with H-124 & H-125 tooling

**Hexagonal Hank
Bush Tooling**

INCH/METRIC

Part#	Fastener Size	Dim. A in./mm	Dim. B in./mm	Dia. C in./mm	Dia. D in./mm
10-00696	M2.5/M3	3.0/76.2	2.5/63.5	.50/12.7	.356/9.0
10-00697	M3.5/M4	3.0/76.2	2.5/63.5	.50/12.7	.356/9.0
10-00698	M5	3.0/76.2	2.5/63.5	.50/12.7	.427/10.8
10-00699	M6	3.0/76.2	2.5/63.5	.50/12.7	.500/12.7
10-00700	M8	3.0/76.2	2.5/63.5	.62/15.7	.620/15.7

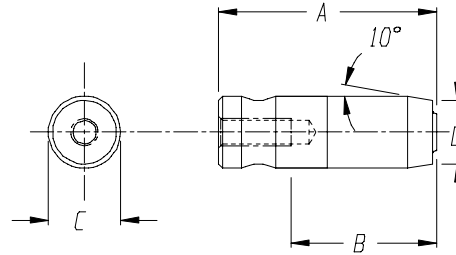

Note: The Pin Style Nut Tooling is recommended for use with these tools.

**Round & Tank
Hank Bush Tooling**

INCH/METRIC

Part #	Fastener Size	Dim. A in./mm	Dim. B in./mm	Dia. C in./mm	Dia. D in./mm
10-00691	M2.5/M3	3.0/76.2	2.5/63.5	.50/12.7	.311/07.9
10-00692	M3.5/M4	3.0/76.2	2.5/63.5	.50/12.7	.375/09.5
10-00693	M5	3.0/76.2	2.5/63.5	.50/12.7	.437/11.1
10-00694	M6	3.0/76.2	2.5/63.5	.50/12.7	.500/12.7
10-00695	M8	3.0/76.2	2.5/63.5	.62/15.7	.620/15.7

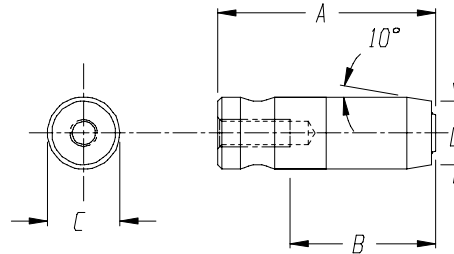

Note: The Pin Style Nut Tooling is recommended for use with these tools.

**Hank Mini-Sert
Tooling**

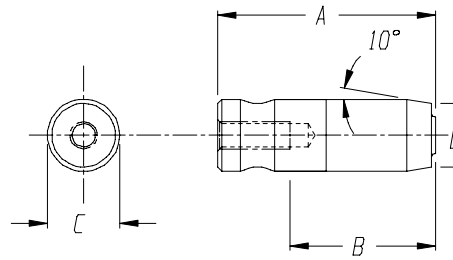

INCH/METRIC

Part #	Fastener Size	Dim. A in./mm	Dim. B in./mm	Dia. C in./mm	Dia. D in./mm
10-00701	M2.5/M3	3.0/76.2	2.5/63.5	.50/12.7	.217/5.5
10-00702	M3.5/M4	3.0/76.2	2.5/63.5	.50/12.7	.276/7.0
10-00703	M5	3.0/76.2	2.5/63.5	.50/12.7	.335/8.5
10-00704	M6	3.0/76.2	2.5/63.5	.50/12.7	.394/10.0
10-00705	M8	3.0/76.2	2.5/63.5	.50/15.7	.472/12.0

Punch MINIANCHOR

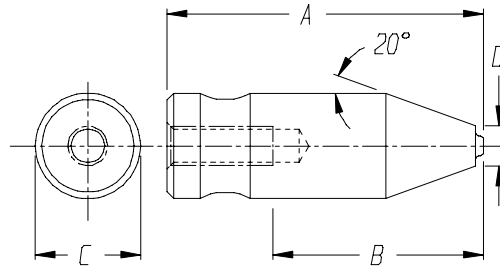

INCH/METRIC

Part #	Fastener Size	Dim. A in./mm	Dim. B in./mm	Dia. C in./mm	Dia. D in./mm
10-00685	M2	3.0/76.2	2.5/63.5	.50/12.7	.189/4.8
10-00686	M2.5/M3	3.0/76.2	2.5/63.5	.50/12.7	.216/5.5
10-00687	M3.5/M4	3.0/76.2	2.5/63.5	.50/12.7	.279/7.5
10-00688	M5	3.0/76.2	2.5/63.5	.50/12.7	.342/8.7
10-00689	M6	3.0/76.2	2.5/63.5	.50/12.7	.310/7.9
10-00690	M8	3.0/76.2	2.5/63.5	.50/12.7	.500/12.7

Note: The Pin Style Nut Tooling is recommended for use with these tools.

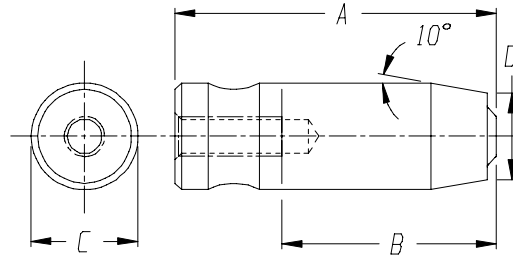

Punch ANCHOR

INCH/METRIC

Part #	Fastener Size	Dim. A in./mm	Dim. B in./mm	Dia. C in./mm	Dia. D in./mm
10-00679	M2/M2.5/M3	3.0/76.2	2.5/63.5	.50/12.7	.297/7.5
10-00681	M3.5/M4	3.0/76.2	2.5/63.5	.50/12.7	.342/8.7
10-00682	M5	3.0/76.2	2.5/63.5	.50/12.7	.405/10.3
10-00683	M6	3.0/76.2	2.5/63.5	.50/12.7	.468/11.9
10-00684	M8	3.0/76.2	2.5/63.5	.61/15.5	.610/15.5

Note: The Pin Style Nut Tooling is recommended for use with these tools.

STP (35 Pieces)

Part NO.	Description
H-170-1	Square Tip Tool Holder
H-167-1	J-Frame Attachment
H-100-0	Flat Anvil
10-00650	2-56 J-Frame Pin Style Tool
10-00651	4-40 J-Frame Pin Style Tool
10-00652	6-32 J-Frame Pin Style Tool
10-00653	8-32 J-Frame Pin Style Nut Tool
10-00654	10-32 J-Frame Pin Style Nut Tool
10-00655	04-32 J-Frame Pin Style Nut Tool
H-102-2	2-56 J-Frame Stud Tool
H-102-4	4-40 J-Frame Stud Tool
H-102-6	6-32 J-Frame Stud Tool
H-102-8	8-32 J-Frame Stud Tool
H-102-10	10-32 J-Frame Stud Tool
H-108-0019S	1/2" Flat Anvil, 1-1/2" long
H-108-0019L	1/2" Flat Anvil, 3" long
H-108-0020S	1" Flat Anvil, 1-1/2" long
H-108-0020L	1" Flat Anvil, 3" long
10-00278	2-56 Pin Style Nut Tool, 3" long
10-00279	4-40 Pin Style Nut Tool, 3" long
10-00280	6-32 Pin Style Nut Tool, 3" long
10-00281	8-32 Pin Style Nut Tool, 3" long
10-00282	10-32 Pin Style Nut Tool, 3" long
10-00283	04-20 Pin Style Nut Tool, 3" long
10-00284	5/16-18 Pin Style Nut Tool, 3" long
H-103-2L	2-56 Stud Tool, 3" long
H-103-4L	4-40 Stud Tool, 3" long
H-103-6L	6-32 Stud Tool, 3" long
H-103-8L	8-32 Stud Tool, 3" long
H-103-10L	10-32 Stud Tool, 3" long
H-103-04L	04-20 Stud Tool, 3" long
H-103-05L	5/16-18 Stud Tool, 3" long
H-109-4/M3L	4-40 Standoff Tool, 3" long
H-109-6/M3.5L	6-32 Standoff Tool, 3" long
H-109-8-10/M5L	8-32 and 10-32 Standoff Tool, 3" long

Note: This package is available with pocket style nut tools as **STP-PS**

MSTP (33 Pieces)

Part NO.	Description
H-170-1	Square Tip Tool Holder
H-167-1	J-Frame Attachment
H-100-0	Flat Anvil
10-00656	M2.5 J-Frame Pin Style Tool
10-00657	M3 J-Frame Pin Style Tool
10-00658	M3.5 J-Frame Pin Style Tool
10-00659	M4 J-Frame Pin Style Nut Tool
10-00660	M5 J-Frame Pin Style Nut Tool
10-00661	M6 J-Frame Pin Style Nut Tool
H-102-M3	M3 J-Frame Stud Tool
H-102-M3.5	M3.5 J-Frame Stud Tool
H-102-M4	M4 J-Frame Stud Tool
H-102-M5	M5 J-Frame Stud Tool
H-108-0019S	12.7mm Flat Anvil, 38mm long
H-108-0019L	12.7mm Flat Anvil, 76mm long
H-108-0020S	25.4mm Flat Anvil, 38mm long
H-108-0020L	25.4mm Flat Anvil, 76mm long
10-00292	M2.5 Pin Style Nut Tool, 76mm long
10-00293	M3 Pin Style Nut Tool, 76mm long
10-00294	M3.5 Pin Style Nut Tool, 76mm long
10-00295	M4 Pin Style Nut Tool, 76mm long
10-00296	M5 Pin Style Nut Tool, 76mm long
10-00297	M6 Pin Style Nut Tool, 76mm long
10-00298	M8 Pin Style Nut Tool, 76mm long
H-103-M3L	M3 Stud Tool, 76mm long
H-103-M3.5L	M3.5 Stud Tool, 76mm long
H-103-M4L	M4 Stud Tool, 76mm long
H-103-M5L	M5 Stud Tool, 76mm long
H-103-M6L	M6 Stud Tool, 76mm long
H-103-M8L	M8 Stud Tool, 76mm long
H-109-4/M3L	M3 Standoff Tool, 76mm long
H-109-6/M3.5L	M3.5 Standoff Tool, 76mm long
H-109-8-10/M5L	M4/M5 Standoff Tool, 76mm long

Note: This package is available with pocket style nut tools as **MSTP-PS**

STP-516 (16 Pieces)

Part NO.	Description
H-108-0019S	1/2" Flat Anvil, 1-1/2" Long
H-108-0019L	1/2" Flat Anvil, 3" Long
H-108-0020S	1" Flat Anvil, 1-1/2" Long
H-108-0020L	1" Flat Anvil, 3" Long
10-00279	4-40 Pin Style Nut Tool, 3" Long
10-00280	6-32 Pin Style Nut Tool, 3" Long
10-00281	8-32 Pin Style Nut Tool, 3" Long
10-00282	10-32 Pin Style Nut Tool, 3" Long
10-00283	04-20 Pin Style Nut Tool, 3" Long
H-103-4L	4-40 Stud Tool, 3" Long
H-103-6L	6-32 Stud Tool, 3" Long
H-103-8L	8-32 Stud Tool, 3" Long
H-103-10L	10-32 Stud Tool, 3" Long
H-109-4/M3L	4-40 Standoff Tool, 3" Long
H-109-6/M3.5L	6-32 Standoff Tool, 3" Long
H-109-8-10/M5L	8-32 and 10-32 Standoff Tool, 3" Long

STP-J-516 (11 Pieces)

Part NO.	Description
H-167-1	J-Frame Attachment
H-100-0	Flat Anvil
10-00651	4-40 J-Frame Pin Style Nut Tool
10-00652	6-32 J-Frame Pin Style Nut Tool
10-00653	8-32 J-Frame Pin Style Nut Tool
10-00654	10-32 J-Frame Pin Style Nut Tool
10-00655	04-20 J-Frame Pin Style Nut Tool
H-102-4	4-40 J Frame Stud Tool
H-102-6	6-32 J Frame Stud Tool
H-102-8	8-32 J Frame Stud Tool
H-102-10	10-32 J Frame Stud Tool

MSTP-516 (16 Pieces)

Part NO.	Description
H-108-0019S	12.7mm Flat Anvil, 38mm Long
H-108-0019L	12.7mm Flat Anvil, 76mm Long
H-108-0020S	25.4mm Flat Anvil, 38 Long
H-108-0020L	25.4mm Flat Anvil, 76mm Long
10-00293	M3 Pin Style Nut Tool, 76mm Long
10-00294	M3.5 Pin Style Nut Tool, 76mm Long
10-00295	M4 Pin Style Nut Tool, 76mm Long
10-00296	M5 Pin Style Nut Tool, 76mm Long
10-00297	M6 Pin Style Nut Tool, 76mm Long
H-103-M3L	M3 Stud Tool, 76mm Long
H-103-M3.5L	M3.5 Stud Tool, 76mm Long
H-103-M4L	M4 Stud Tool, 76mm Long
H-103-M5L	M5 Stud Tool, 76mm Long
H-109-4/M3L	M3 Standoff Tool, 76mm Long
H-109-6/M3.5L	M3.5 Standoff Tool, 76mm Long
H-109-8-10/M5L	M4/M5 Standoff Tool, 76mm Long

MSTP-J-516 (11 Pieces)

Part NO.	Description
H-167-1	J-Frame Attachment
H-100-0	Flat Anvil
10-00657	M3 J-Frame Pin Style Nut Tool
10-00658	M3.5 J-Frame Pin Style Nut Tool
10-00659	M4 J-Frame Pin Style Nut Tool
10-00660	M5 J-Frame Pin Style Nut Tool
10-00661	M6 J-Frame Pin Style Nut Tool
H-102-M3	M3 J Frame Stud Tool
H-102-M3.5	M3.5 J Frame Stud Tool
H-102-M4	M4 J Frame Stud Tool
H-102-M5	M5 J Frame Stud Tool

BTM Tog-L-Loc Joining Tooling

For use on Haeger Press

The joining process involves clinching ductile metals with a single ram stroke. Joining produces an instant button headed joint in most ductile metals without using fasteners of any kind.

The two metals to be joined are held between a special punch and die. The non-piercing punch draws the metals into the die. As the punch continues it's travel, it squeezes the metals. The lateral flow of metal is accommodated by moving die blades, forming a lock of greater diameter than the drawn section. The result is an instant, high strength, vibration resistant "button" head. This takes place in a single ram stroke.

Joining has numerous advantages over both spot welding and riveting. It's environmentally clean, producing no sparks or noxious fumes. Additionally, pre-coated surfaces are not burned and no heat build-up or warping occurs. Joining does not require any preliminary operations and eliminates the need for a rivet inventory.

Brass, aluminum, galvanized, pre-painted, mild steel and stainless (with different type of tooling) are all capable of being joined together. Both similar and dissimilar material can be joined.

In addition to installing hardware, the Haeger press can be used for these joining applications. The Haeger press has a much greater throat depth than presses built by joining machine manufacturers, allowing for much greater versatility. Plus if you already own a Haeger, you only need to buy a tooling set to be able to perform joining applications.

There are five tooling components required to perform joining operations on a Haeger Press: a special upper tool holder, a special lower tool holder, a punch assembly, a die assembly and a die holder. The upper tool holder and the lower tool holder are both one-time purchases.

Set-up and Operating Instructions For using BTM Joining Tooling on Haeger Press

1. Install the special lower tool holder onto the lower part of the C-Frame. The adjustable guide inside the lower tool holder must be firmly pressing against the mounting screw.
2. Install the die holder into the lower tool holder and then mount the die assembly into the die holder. These items will likely be assembled when shipped.
3. Mount the special tool holder onto the ram and then mount the punch assembly into the upper tool holder.
4. Remove the spring cover and spring around the outside of the punch assembly so the punch is exposed.
5. Put the Haeger press in set-up mode and non-conductive mode. Set the pressure to it's lowest setting.
6. Bring the ram down until the punch is just above the die assembly. Adjust the lower tool holder until the punch is precisely centered on the lower tool anvil.
7. Move the ram up and replace the stripper and spring.
8. Return the press to run mode and conductive mode.
9. Place the material between the upper and lower tools and bring the ram down and apply pressure.
10. Check the diameter of the button on the bottom of the joined material. Increase pressure until the desired button diameter is reached.

Should you require any assistance, please contact your distributor or Haeger's service department.

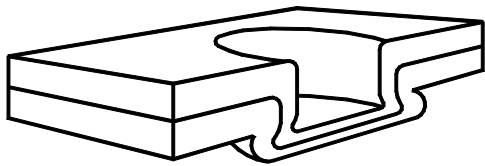

Tog-L-Loc is a circular, leakproof joint formed by drawing the metals into a circular “cup” and then expanding the diameter to form a 360° radial lock below the bottom sheet.

How the Joining Process Works

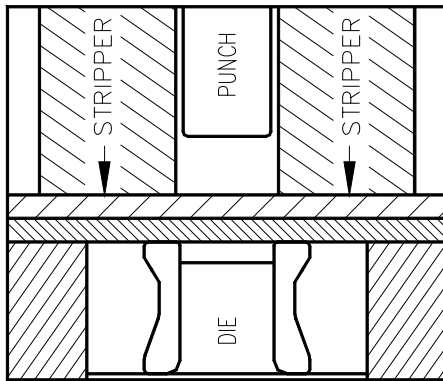

1. CLAMPS

The metals are clamped between the stripper and the die guard.

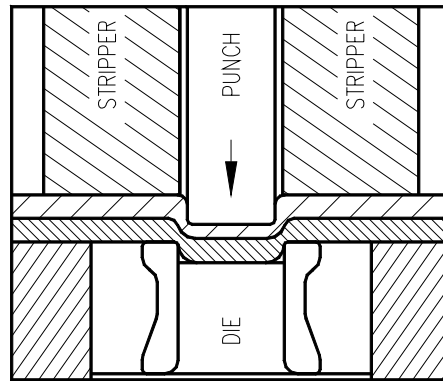

2. DRAWS

The non-piercing punch draws the metal into the die.

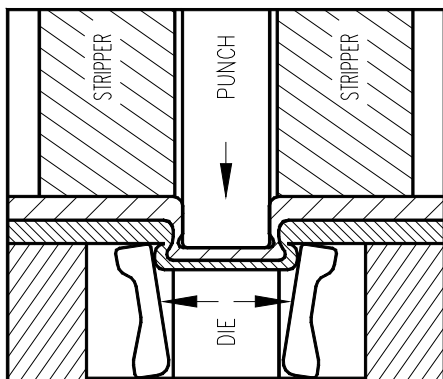

3. LOCKS

The punch continues to travel, squeezing the metals.

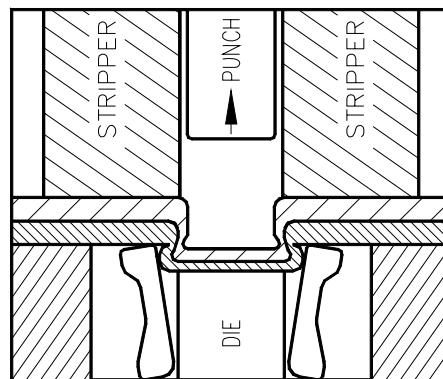

4. STRIPS

As the punch retracts, the stripper allows the punch to be removed.

The lateral flow of metal is accommodated by the patented moving (self-cleaning) die blades, forming a lock of greater diameter than the drawn section which accounts for high strength and vibration resistance of Tog-L-Loc. This entire sequence takes place in a single motion or press stroke.

**TECHNICAL DESCRIPTION
BTM JOINT**

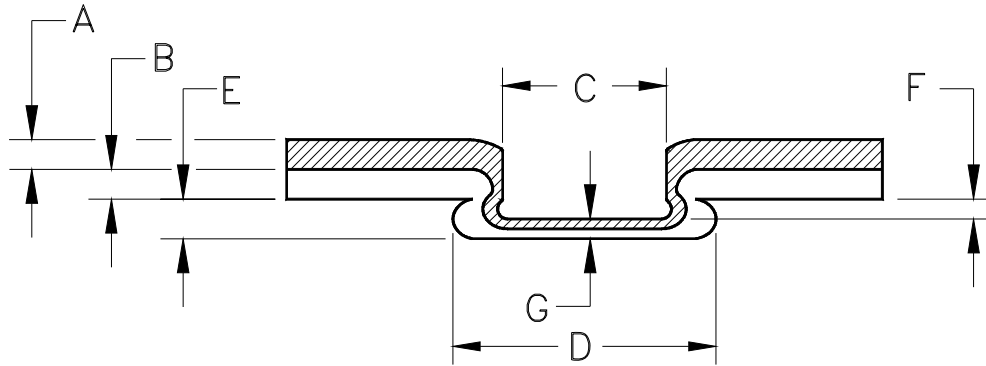

- A = PUNCH SIDE MATERIAL
- B = DIE SIDE MATERIAL
- C = JOINT SIZE (PUNCH TIP DIAMETER)
- D = BUTTON DIMENSION OR DIAMETER
- E = CAP HEIGHT
- F = PUNCH ENTRY INTO DIE (ESTIMATED 2/3 OF ANVIL DEPTH)
- G = CAP THICKNESS

TOG-L-LOC JOINTS CAN BE CHECKED NON-DESTRUCTIVELY USING THIS SIMPLE GAGE. THE "BUTTON" MUST MEASURE WITHIN THE TOLERANCE OF THE GAGE.

MAX.

BTM "GO-NO GO" GAGES ARE A SIMPLE OPTION FOR MEASURING THE BUTTON DIAMETER.

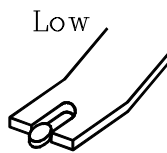
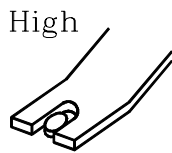

MEASURING JOINT BUTTON DIAMETER (BD).

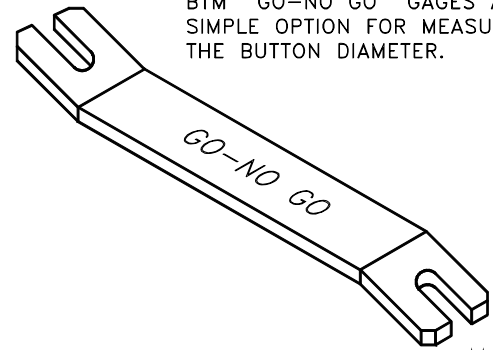

MIN.

Three joint sizes are available as shown below:

<u>Joint required</u>	<u>Punch Diameter</u>	<u>Approximant Tonnage</u>
12	3mm (.12")	.12—2.5 Tons
18	4.6mm (.18")	.18—3.5 Tons

1. Select joint size.
2. Determine both punch side and die side material type and thickness.
3. Look up application on joint data table. Verify shear and peel strength are acceptable.
4. Determine punch tip radius and anvil depth.
5. Select appropriate tooling from the chart on next page.
6. Not recommended for use with Stainless Steel.

Joint	Part #	Description
All	H-3501-5	BTM Upper Tool Holder
12	15-01808	.12 ½" Dia. Die Holder for H-166-8
18	15-01523	.18 ½" Dia. Die Holder for H-166-8
12	006742	Punch Assy. .12" (.010 PTR)
12	004933	Punch Only .12" (.010 PTR)
12	006744	Punch Assy. .12" (.020 PTR)
12	006011	Punch Only .12" (.020 PTR)
12	006709	Die Assy. .12" (.030 AD)
12	006711	Die Assy. .12" (.035 AD)
12	006713	Die Assy. .12" (.040 AD)
12	006715	Die Assy. .12" (.045 AD)
18	007747	Punch Assy. .18" (.010 PTR)
18	002798	Punch Only .18" (.010 PTR)
18	007116	Punch Assy. .18" (.020 PTR)
18	002992	Punch Only .18" (.020 PTR)
18	003954	Die Assy. .18" (.035 AD)
18	003961	Die Assy. .18" (.040 AD)
18	003969	Die Assy. .18" (.045 AD)
18	003977	Die Assy. .18" (.050 AD)
18	004037	Die Assy. .18" (.055 AD)
All	H-147-2	BTM Lower Tool Holder for Heavy Duty Applications
12	013681	¾" Dia. .12 Die Holder
18	007689	¾" Dia. .18 Die Holder

4 components are required using the 1/2" Die Holder - Upper Tool Holder, ½" Die Holder, Punch Assy. & Die Assy.

5 components are required using the 3/4" Die Holder - Upper Tool Holder, ¾" Lower Tool Holder, ¾" Die Holder, Punch Assy. & Die Assy.

**BTM JOINT DATA TABLE
.12 Punch Diameter (3) Bladed Dies**

Metal Thickness INCH			Anvil Depth	Button Dim.	Joint Strength lbf	
Punch Side	Die Side	Punch Tip Radius			Shear	Peel
.024	.024	.010	.030	.185	190	20
.030	.024	.010	.030	.185	220	20
.040	.024	.010	.030	.190	280	20
.048	.024	.010	.035	.190	300	25
.060	.024	.020	.035	.195	400	30
.030	.030	.010	.030	.195	200	35
.040	.030	.010	.035	.195	230	35
.048	.030	.010	.035	.200	300	40
.060	.030	.020	.040	.200	400	60
.040	.040	.010	.040	.205	195	75
.048	.040	.010	.040	.205	225	100
.060	.040	.020	.040	.210	350	90
.048	.048	.010	.040	.205	230	90
.060	.048	.020	.045	.210	345	95
.060	.060	.020	.045	.210	250	90
.074	.024	.020	.045	.200	400	40
.074	.030	.020	.045	.200	450	55
.074	.040	.020	.045	.205	400	70
.074	.048	.020	.045	.205	375	90

**BTM JOINT DATA TABLE
3mm Punch Diameter (3) Bladed Dies**

Metal Thickness Metric		Punch Tip Radius	Anvil Depth	Button Dim.	Joint Strength (N)	
Punch Side	Die Side				Shear	Peel
.6mm	.6mm	.25mm	.75mm	4.7mm	845	89
.75mm	.6mm	.25mm	.75mm	4.7mm	978	89
1.0mm	.6mm	.25mm	.75mm	4.8mm	1245	89
1.2mm	.6mm	.25mm	.9mm	4.8mm	1334	111
1.5mm	.6mm	.50mm	.50mm	4.95mm	1779	133
.75mm	.75mm	.25mm	.75mm	4.95mm	889	156
1.0mm	.75mm	.25mm	.9mm	4.95mm	1023	156
1.2mm	.75mm	.25mm	.9mm	5.1mm	1334	178
1.5mm	.75mm	.50mm	1.0mm	5.1mm	1779	267
1.0mm	1.0mm	.25mm	1.0mm	5.2mm	867	334
1.2mm	1.0mm	.25mm	1.0mm	5.2mm	1000	445
1.5mm	1.0mm	.50mm	1.0mm	5.3mm	1557	400
1.2mm	1.2mm	.25mm	1.0mm	5.2mm	1023	400
1.5mm	1.2mm	.50mm	1.75mm	5.3mm	1534	422
1.5mm	1.5mm	.50mm	1.75mm	5.3mm	1112	400
1.9mm	.6mm	.50mm	1.75mm	5.1mm	1779	178
1.9mm	.75mm	.50mm	1.75mm	5.1mm	2002	245
1.9mm	1.0mm	.50mm	1.75mm	5.2mm	1779	311
1.9mm	1.2mm	.50mm	1.75mm	5.2mm	1668	400

**BTM JOINT DATA TABLE
.18 Punch Diameter (3) Bladed Dies**

Metal Thickness INCH						
Punch Side	Die Side	Punch Tip Radius	Anvil Depth	Button Dim.	Joint Strength lbf	
					Shear	Peel
.024	.024	.010	.035	.265	300	70
.030	.024	.010	.035	.265	340	70
.040	.024	.010	.035	.270	3758	70
.048	.024	.010	.035	.275	450	75
.060	.024	.010	.045	.280	550	80
.030	.030	.010	.035	.270	375	75
.040	.030	.010	.040	.275	440	100
.048	.030	.010	.040	.280	450	75
.060	.030	.020	.045	.280	625	100
.040	.040	.010	.045	.280	400	100
.048	.040	.010	.045	.290	475	130
.060	.040	.020	.050	.295	550	150
.048	.048	.010	.045	.290	430	150
.060	.048	.020	.055	.295	522	180
.060	.060	.020	.055	.295	475	175
.067	.060	.020	.055	.295		
.080	.060	.020	.055	.295		
.087	.060	.020	.055	.300		
.098	.060	.020	.055	.300		
.067	.067	.020	.055	.295		
.080	.067	.020	.055	.300		
.087	.067	.020	.055	.300		
.098	.067	.020	.055	.300		
.080	.080	.020	.055	.300		
.087	.080	.020	.055	.300		

**BTM JOINT DATA TABLE
4.6mm Punch Diameter (3) Bladed Dies**

Metal Thickness		Metric	Anvil Depth	Button Dim.	Joint Strength (N)	
Punch Side	Die Side	Punch Tip Radius			Shear	Peel
.6mm	.6mm	.25mm	.9mm	6.7mm	1334	311
.75mm	.6mm	.25mm	.9mm	6.7mm	1512	311
1.0mm	.6mm	.25mm	.9mm	6.8mm	1668	311
1.2mm	.6mm	.25mm	.9mm	6.9mm	2002	334
1.5mm	.6mm	.25mm	1.1mm	7.1mm	2447	356
.75mm	.75mm	.25mm	.9mm	6.8mm	1668	334
1.0mm	.75mm	.25mm	1.0mm	6.9mm	1957	445
1.2mm	.75mm	.25mm	1.0mm	7.1mm	2001	334
1.5mm	.75mm	.25mm	1.1mm	7.1mm	2780	445
1.0mm	1.0mm	.25mm	1.1mm	7.1mm	1779	445
1.2mm	1.0mm	.25mm	1.1mm	7.3mm	2113	578
1.5mm	1.0mm	.50mm	1.3mm	7.5mm	2446	667
1.2mm	1.2mm	.25mm	1.1mm	7.5mm	1913	667
1.5mm	1.2mm	.50mm	1.4mm	7.5mm	2322	801
1.5mm	1.5mm	.50mm	1.4mm	7.5mm	2113	778
1.7mm	1.5mm	.50mm	1.4mm	7.5mm		
2.0mm	1.5mm	.50mm	1.4mm	7.5mm		
2.2mm	1.5mm	.50mm	1.4mm	7.6mm		
2.5mm	1.5mm	.50mm	1.4mm	7.6mm		
1.7mm	1.7mm	.50mm	1.4mm	7.5mm		
2.0mm	1.7mm	.50mm	1.4mm	7.6mm		
2.2mm	1.7mm	.50mm	1.4mm	7.6mm		
2.5mm	1.7mm	.50mm	1.4mm	7.6mm		
2.0mm	2.0mm	.50mm	1.4mm	7.6mm		
2.2mm	2.0mm	.50mm	1.4mm	7.6mm		

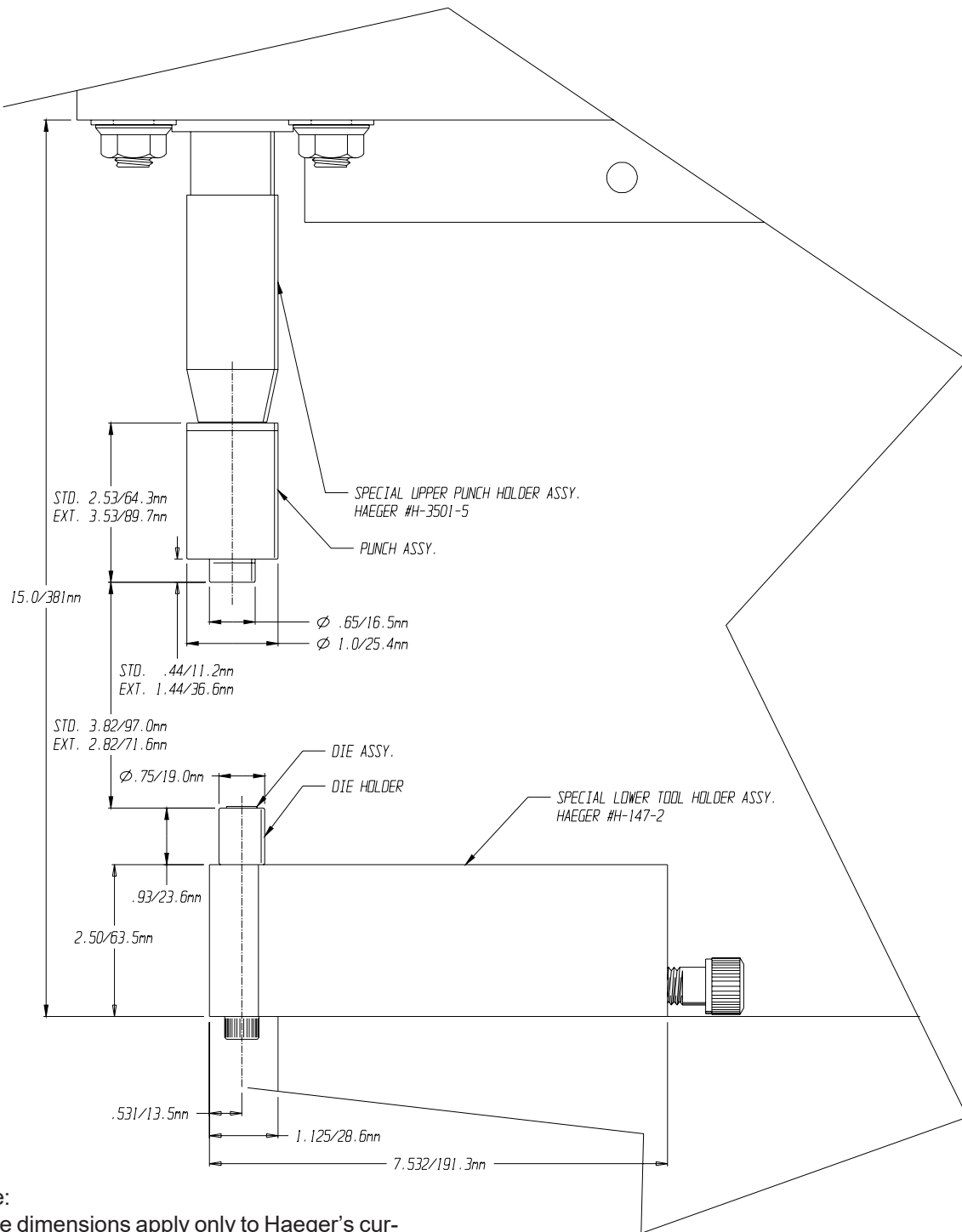

***Note:**
These dimensions apply only to Haeger's current 618 and 824 models. For all other models, these dimensions may vary slightly.

Standard Punches

PTR

Part No. Description

in./mm

006742	Complete Punch Assembly	.010/.25
004933	Replacement Punch	.010/.25
003654	Replacement Stripper Spring	
006744	Complete Punch Assembly	.020/.51
006011	Replacement Punch	.020/.51
003654	Replacement Stripper Spring	

Extended Tip Punches

PTR

Part No. Description

in./mm

006743	Complete Punch Assembly	.010/.25
006622	Replacement Punch	.010/.25
003654	Replacement Stripper Spring	
006745	Complete Punch Assembly	.020/.51
006623	Replacement Punch	.020/.51
003654	Replacement Stripper Spring	

Dies

AD

Part No. Description

in./mm

15-01808	.12-1/2" DIA Die Holder	
006709	Die Assembly	.030/0.76
006711	Die Assembly	.035/0.89
006713	Die Assembly	.040/1.02
006715	Die Assembly	.045/1.14
004510	Die Elastomer, .12	

Special Haeger Tool Holders

Part No. Description

H-3501-5	Special Upper Tool Holder Assembly
H-166-8	Lower Tool Holder Assembly

.12 Joint BTM Tooling

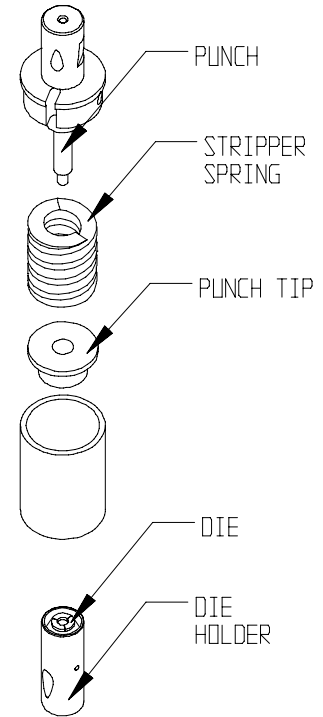

Notes:

1. PTR = Punch Tip Radius
2. AD = Anvil Depth
3. These tools may be used on most Haeger machines. Please consult Haeger's Specials Group for recommendations.

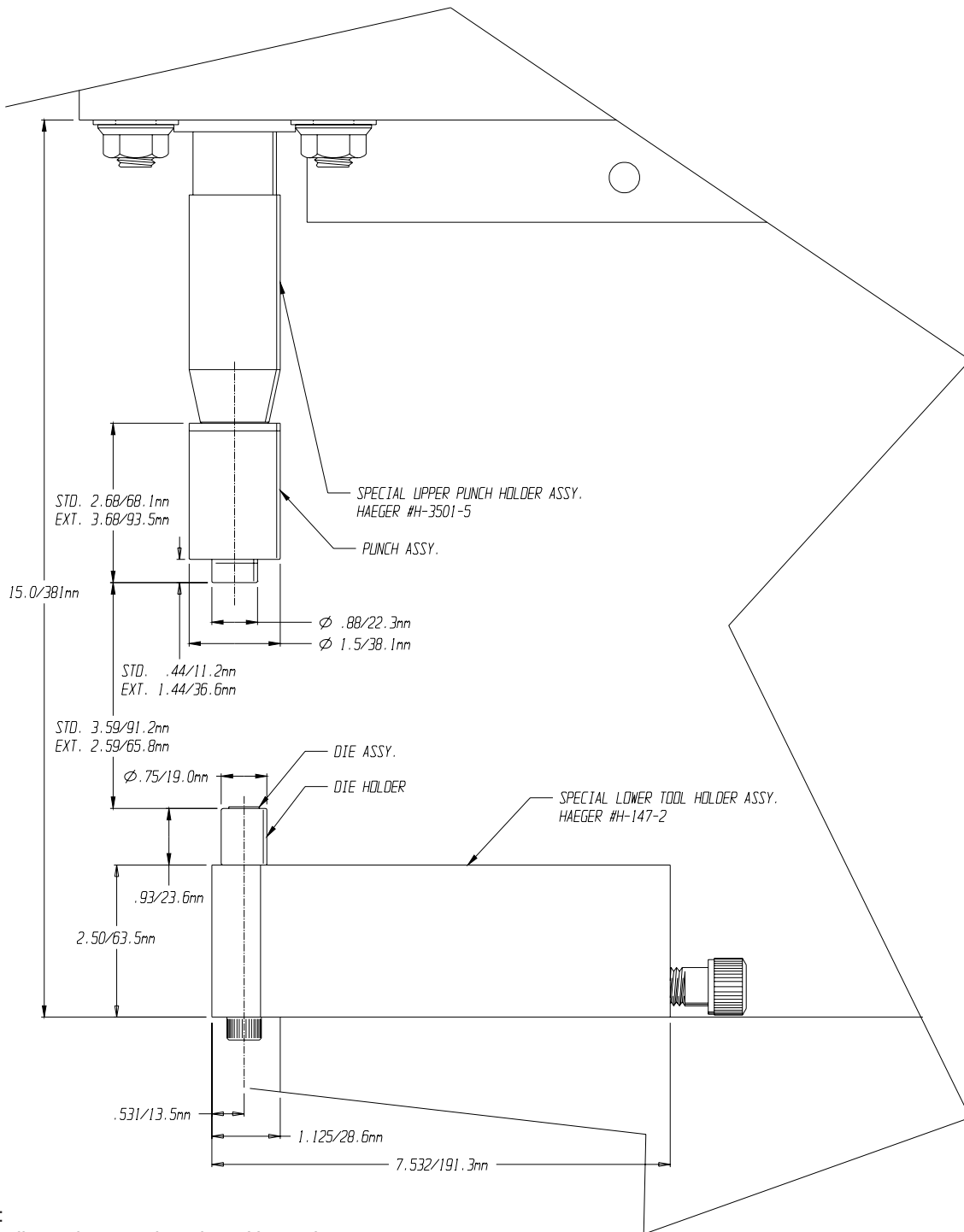

***Note:**
These dimensions apply only to Haeger's current 618 and 824 models. For all other models, these dimensions may vary slightly.

Standard Punches

PTR

Part No.	Description	in./mm
007747	Complete Punch Assembly	.010/.25
002798	Replacement Punch	.010/.25
006388	Replacement Stripper Spring	
007116	Complete Punch Assembly	.020/.51
002992	Replacement Punch	.020/.51
006388	Replacement Stripper Spring	

Extended Punches

PTR

Part No.	Description	in./mm
013573	Complete Punch Assembly	.010/.25
006624	Replacement Punch	.010/.25
006388	Replacement Stripper Spring	
013588	Complete Punch Assembly	.020/.51
006636	Replacement Punch	.020/.51
006388	Replacement Stripper Spring	

Dies

AD

Part No.	Description	in./mm
18-01523	.18-1/2" DIA Die Holder	
003954	Die Assembly	.035/0.89
003969	Die Assembly	.045/1.14
003977	Die Assembly	.050/1.27
004037	Die Assembly	.055/1.40
004500	Die Elastomer, .18	

Special Haeger Tool Holders

Part No.	Description
H-3501-5	Special Upper Tool Holder Assembly
H-147-2	Special Lower Tool Holder Assembly

.18 Joint BTM Tooling

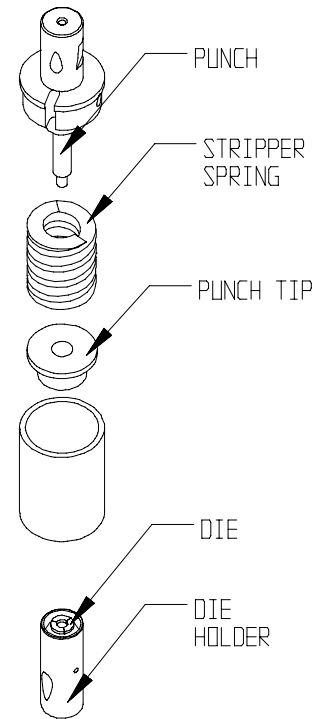

Notes:

1. PTR = Punch Tip Radius
2. AD = Anvil Depth
3. These tools may be used on most Haeger machines. Please consult Haeger's Specials Group for recommendations.

Complete Assembly Part No. H-3501-5

Item	Part No.	Description	Qty.
1	H-149-1	Upper Tool Holder Body	1
2	H-215-125	Continuity Spring	1
3	H-195-1	Continuity Spring Guide Pin	1
4	H-3700	10-32 X 7/16 Thumb Screw	1
5	H-3548	10-32 X 1/4 SHSS	1
6	H-3549	10-32 X 3/8 SHCS	1
7	H-3773	1/4-28 X 1/4 SHSS	1

Note: This tool holder may be used on the HP2.5, HP6, 618 and 824 machines.

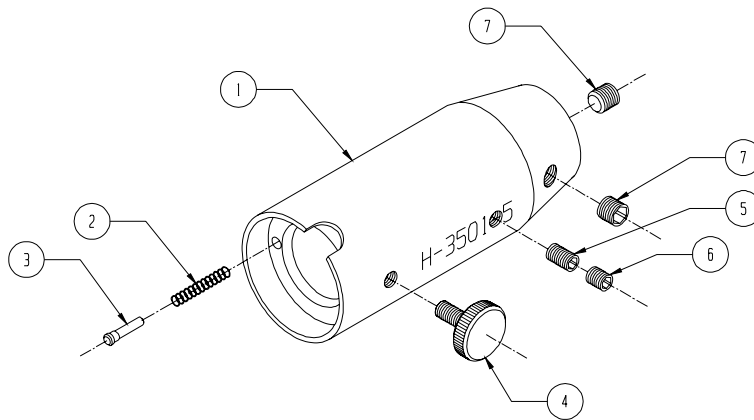

Complete Assembly Part No. H-166-8

Item	Part No.	Description	Qty.
1	H-166-8	Lower Tool Holder Assy	1
2	11-00042	Locking Lever	1
3	11-00041	Lock Cylinder	1
4	11-00212	Lock Cylinder Spring	1
5	11-00199	Spring Roll Pin, 1/8 X 1/4	1
6	H-3568	#10-32 X 1" BHCS	1
7	H-169-6	Lower Tool Washer	1
8	11-00191	M16X2 SHCS Modified	1
9	H-169-4	Shoe	1
10	H-169-5	Pin	1

Note: This tool holder may be used on all HP2.5, HP6, 618, 824, 618 Plus, and 824 Plus machines.

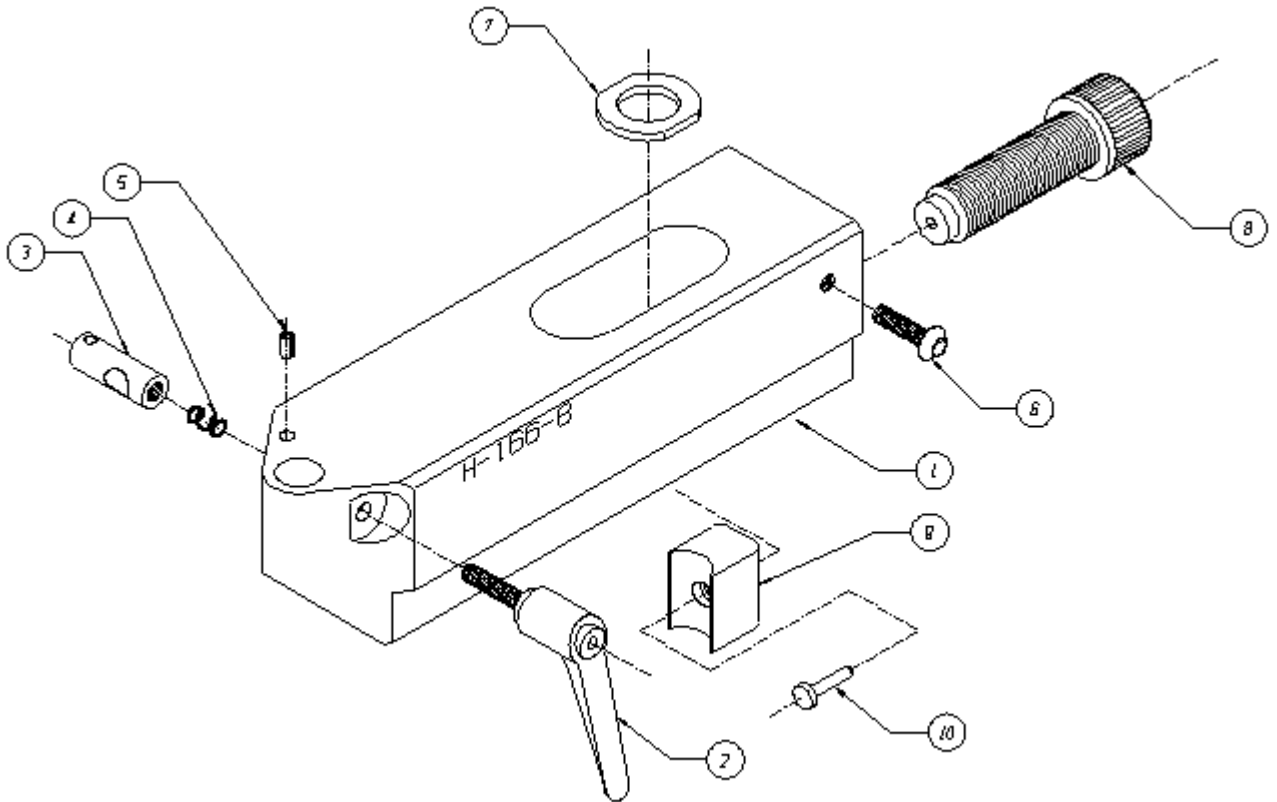

Complete Assembly Part No. H-147-2

Item	Part No.	Description	Qty.
1	H-147-1	Lower Tool Holder Body	1
2	H-169-4	Shoe	1
3	H-169-5	Pin	1
4	11-00191	M16 SHCS Modified	1
5	H-169-6	Lower Tool Washer	1
6	H-3859	3/8-24 X 2 SHCS	1
7	H-3773	1/4-28 X 1/4 SHSS	1
8	H-3890	5/8-18 X 2-3/4 SHCS	1
9	11-00190	M16 X 2.0 X 65 SHCS	1

Note: This tool holder may be used on the HP2.5, HP6, 618 and 824 machines.

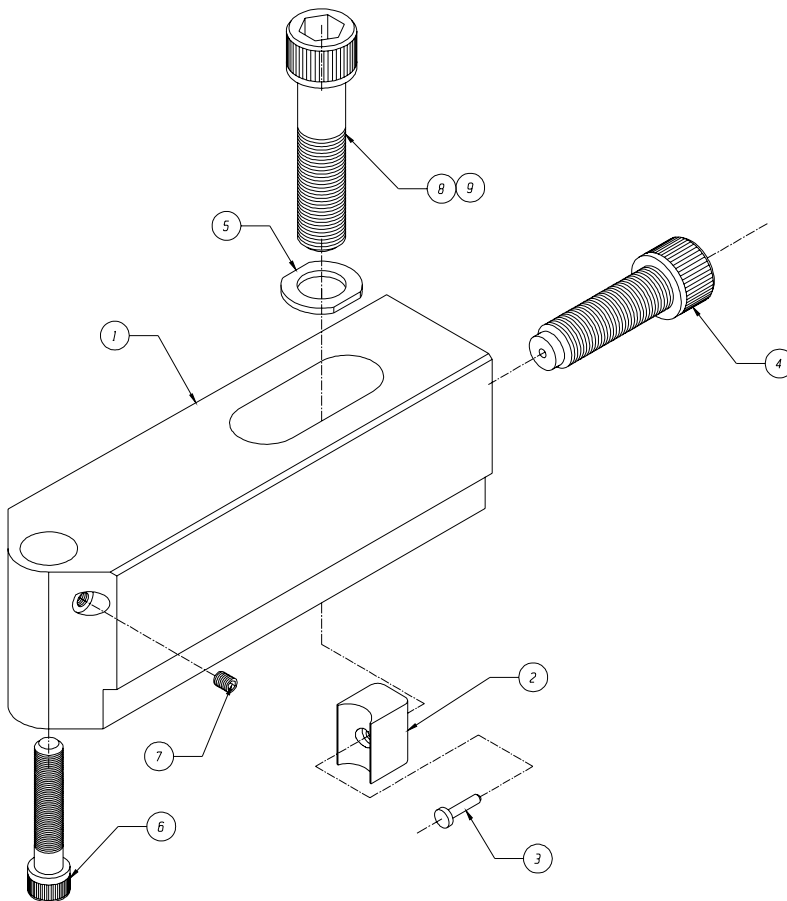

Complete Assembly Part No. H-170-1

Item	Part No.	Description	Qty.
1	H-170-1	Sq. Nose Lwr Tool Holder Assy	1
2	11-00191	M16 SHCS Modified	1
3	H-169-4	Shoe	1
4	H-169-5	Pin	1
5	H-3625	8-32 X 1/8 SHSS	1
6	H-3761	10-32 5/8 BHCS	1
7	H-169-6	Lower Tool Washer	1

Notes:

1. This tool holder may be used on all HP2.5, HP6, 618 and 824 machines.
2. The J-Frame Stud Tooling (H-102), Pocket Style Nut Tooling (H-100) and the Pin Style Nut Tooling (10-006xxx) may be used in this tool holder.

